

## ELPARTS

**INSTALLATION** Connectors | Attachment parts | Cable straps | Gaskets+grommets | Insulating tape |  
Hoses+pipes | Cables+Cable connections | Battery accessories | Plug housings | Fuses | Plugs+Sockets |  
Assortments



[herthundbuss.com](http://herthundbuss.com)

# ClipFix



 **HERTH+BUSS**

# “Real-life” implemented improvement process

We, the management are committed to the TQM concept, because we value the trust our customers place in us and want to maintain it in the long term.

We see our relationship with our customers as a partnership which must be constantly improved. As a result, we continuously check even established processes for opportunities for improvement.

And not because anyone is forcing us to do so, because we have met the criteria for the ISO certification for a long time.

Instead, we are motivated by the chance to achieve even better results in our work together and to help our customers to increase their competitiveness and hence secure their long-term success.

That is what we call a “real-life implemented improvement process”, and it is also what our many long-term customers especially appreciate about their cooperation with Herth+Buss.



## We are certified according to:

- ISO 9001:2008 Quality management
- VDA 6.2 Quality management
- StVZO Verification



Verband der Automobilindustrie



# Content



<b>Lead</b>	4 - 11
<b>Clamps</b>	12 - 112
<b>Article no. Index</b>	113 - 116
<b>Index</b>	117 - 118

1

# ELPARTS

Electrics | Installation | Tools | Lighting

## From small to large – the whole range!

With our Elparts range we offer a comprehensive product spectrum that meets any requirement, from automobiles to commercial vehicles. This is our professional workshop solution and that's why we're always first choice.

### Our services for you:

- over 7,700 special parts
- comprehensive range for all vehicle types
- exactly fitting parts allocation
- professional solutions thanks to over 90 years of experience

**Passt immer!**



## ELECTRICS

Signal devices



Signal units



Relays



Control units



Switches



Actuators+Sensors



Voltage transformers



Inverter



Alternators+Starters



Wash water pump



Ignition system



## INSTALLATION

Connectors



Attachment parts



Cable straps



Gaskets+Grommets



Insulating tape



Hoses+Pipes



Cables+  
Cable connections



Battery accessories



Plug housings



Fuses



Plugs+Sockets



Assortments



## TOOLS

Release tools



Pliers



Service+Diagnostics



Measuring technology



Battery management



Processing+Installation



Workshop lamps



## LIGHTING

Daytime running lights



Headlights



Lights



Reflectors



Warning equipment



Connection sets



(Lamp) sockets



Bulbs





# Help yourself!

## SHOP TO GO – the ideal partner for perforated walls at the POS



Goods that are presented in a tidy, well thought-out manner with a uniform appearance entice customers to buy and give an impression of a competent and professional business. We are showcasing our new-look, self-service product concept with items from the field of installation. This range includes some of our most-used and most sought-after items. Retailers can select the most important goods for their clientele from the range of self-service products on offer, with the uniform self-service packaging ensuring that they fit onto any conventional perforated wall. A Herth+Buss label is also available for the top of the shelf, so that

customers can already see from afar that they are browsing the self-service range of Herth+Buss parts. What's more, a QR code printed on the packaging provides users who have a smartphone or tablet with additional, detailed product information. A comprehensive self-service catalogue is also available for the self-service range, including products such as connectors, cable straps, cables and cable connections, plugs and sockets, battery accessories, plug housings and fuses. Users can also touch the electric cables on offer to make it easier to recognise and check materials.



QR code on the back leads to further information.

### SHOP TO GO CATALOGUE



Our Shop-to-go catalogue contains everything relating to:

- Connectors
- Cable straps
- Cables+cable connections
- Plugs+sockets
- Battery accessories
- Plug housing
- Fuses

SHOP TO GO catalogue

Article number: **KatalogSBEN**



### Information on our order quantities

Please bear in mind the quantity indicated in the "delivery unit" column (LE) for your planning. We can only deliver the quantities indicated here, or quantities divisible by the delivery unit number.  
1 and higher = parts with a delivery unit

of 1 are packaged individually. All other delivery units are packaged together in the quantity indicated.

New additions to the catalogue are labelled with the "NEW" symbol.

### Squeeze Connector

**Plug Type:** Blade Terminal Sleeve  
**Design:** Partly Insulated  
**DIN / ISO:** 46245



Quantity per delivery unit

Delivery unit

Socket Width mm	Socket Height mm	Cross Section mm <sup>2</sup>	Colour	Quantity	DU	Article no.
6,3	0,8	0,5 to 1		10	1	50252510066
		1,5 to 2,5		10	1	50252511066
<b>Accessories</b>			<b>Cross Section mm<sup>2</sup></b>	<b>see</b>	<b>DU</b>	
Crimping Pliers Insert			0,5 to 1 1,5 to 2,5 4 to 6	Katalog08	1	95942177
Crimping Pliers CrimPro 30				Katalog08	1	95942164
Squeeze Pliers			1,5 to 6	Katalog08		

New in range

SB-packed, see bottom left

### Overview of colour symbols

Compilation of colours used in the catalogue

- |               |                |             |              |
|---------------|----------------|-------------|--------------|
| Beige         | Grey/Red       | Orange      | White/Blue   |
| Blue          | Green          | Pink        | White/Brown  |
| Brown         | Green/Blue     | Red         | White/Yellow |
| Brown/Blue    | Green/White    | Red/Brown   | Red/White    |
| Bronze        | Cast Iron Grey | Red/Yellow  |              |
| Chrome        | Light blue     | Red/Black   |              |
| Dark Grey     | Light brown    | Black       |              |
| Ivory White   | Light green    | Black/Grey  |              |
| Yellow        | Lila           | Black/Green |              |
| Yellow/Blue   | Mat            | Black/White |              |
| Yellow/Black  | Mint green     | Silver      |              |
| Crystal Clear | NATO olive     | Transparent |              |
| Grey          | Natural        | White       |              |



## Overview of IP-Code components (extract)

The protection categories are indicated by an abbreviation which is comprised of the letters IP (International Protection) which always remain the same, followed by two code numbers which represent the degree of protection. The first code number represents the degree of protection against contact and foreign bodies, and the second represents the degree of protection against damage caused by water penetration.

First no.	Level of protection against touch	Level of protection against intrusion of foreign bodies	Second no.	Level of protection against water penetration
0	not protected	not protected	0	not protected
1	back of hand	object with Ø over 50 mm	1	vertical droplets
2	finger	object with Ø over 12.5 mm	2	droplets at 15° tilt
3	tools	object with Ø over 2.5 mm	3	spraying water
4	thin wire	object with Ø over 1 mm	4	splashing water
5	thin wire	dust-protected	4K	splashed water, at high pressure, only for road vehicles
6	complete	dust-tight	5	water jets
			6	powerful water jets
			6K	powerful water jets, at high pressure (flooding), only for road vehicles
			7	temporary submersion
			8	continuous submersion
			9K	for pressure/steam jet cleaning, only for road vehicles

### Example

First code number 6 = complete touch protection and dust-protected  
Second code number 5 = protected against water jets

# VDA

## Verband der Automobilindustrie

### Installation by specialist only

The VDA working group for suppliers' aftermarket business is the representative of parts manufacturers in the German automotive industry, with their global heads in the aftermarket area. One of the main issues addressed by the group is the use of parts safety to constantly guarantee or increase road safety for drivers

It has been noted that driver safety can be put at risk especially by improper installation of parts that are intended for installation by a workshop, not unqualified persons.

The aftermarket working group has therefore commissioned a pictogram for "Installation by specialist only". This pictogram for international use can be attached to the packaging of workshop parts for information purposes and indicates to the consumer that installation by a specialist workshop is recommended. The pictogram symbol has been developed as part of a market research study and successfully tested for clear understanding in a range of countries.





### Cross-linked catalogues!

Our catalogues are cross-linked to provide the quickest and clearest access possible to extensive product information. Parts lists and accessories lists provide information on the scope of delivery and useful accessories. The accessories products can be found either in the same catalogue and are listed with a page reference, or they are products from another catalogue and are provided with an article number.

Accessories	see	DU	
Crimping Pliers Insert Set	Katalog08	1	5942173
Crimping Pliers CrimPro 30	Katalog08	1	5942166
Sealing-/Protection Plugs	Katalog08	1	5942164
	Page 108	1	0282022



#### Practical example

You have found a crimp connector in the Installation Catalogue (Katalog04EN), for example, then you see the corresponding pliers or release tool listed as accessories. Comprehensive information on these tools is then provided in the Tools Catalogue (Katalog08EN).

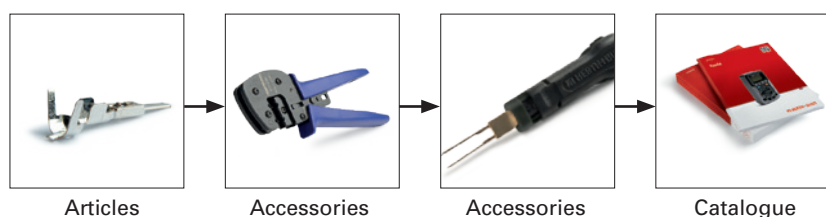



## E-catalogues

Take advantage of the many functions of our interactive e-catalogues. Searching for products here couldn't be easier. Using the full-text search, you can scan the contents of the entire catalogue, regardless of whether you know the article number or just the

name. You can save your search results by either using a bookmark or by generating certain pages as a PDF. You can also use the interactive article numbers. These link directly to our online catalogue, which will provide you with additional information.



[herthundbuss.com/en/catalogues](http://herthundbuss.com/en/catalogues)

**Bookmark** (points to the browser's bookmark icon)

**Save** (points to the 'Seite speichern' button)

**Search** (points to the search bar)

**Page overview** (points to the left sidebar navigation)

**Side view** (points to the 'Seitenansicht' button)

**Page selection** (points to the page number '302 / 724')

**interactive Article no.** (points to the 'LE' article numbers in the product table)

**Next page** (points to the 'Next' navigation button)

### Practical example

You have found a daytime running light set in the Lighting Catalogue (Katalog06EN), for example, but want to find more information such as technical drawings or installation and operating instructions. You can use the interactive article numbers to directly access our online catalogue, which will provide you with detailed information on each product as well as additional product images and the installation and operating instructions.



Article

LE	Artikel-Nr.
1	<b>80659113</b>
LE	<b>75614000</b>

interactive Article no.



Online-Catalogue

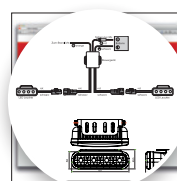

Fitting Instruction  
Operating Instruction

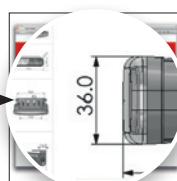

additional images

### Dimension specifications

The dimensions of our body fasteners are specified for the width, height and depth, diameter and pitch circle diameter, amongst other things. This is shown in the catalogue as follows.

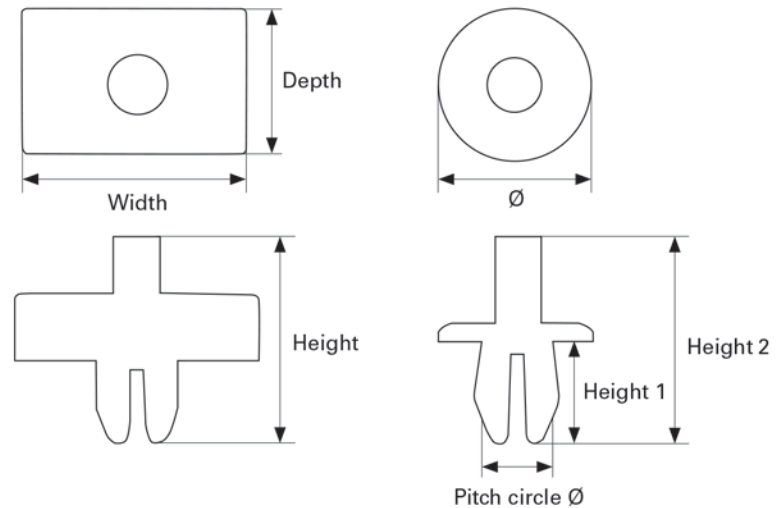

### Legal information

With the publication of this catalogue, all previous offers lose their validity. Only our order confirmation shall be relevant for the subject matter of the contract. We shall supply exclusively on the basis of the latest version of our general conditions of sale and delivery. The catalogue is intended for the commercial sector only. All information in this catalogue has been carefully researched and reproduced. Technical modifications in the course of further development and variations in the shape, colour and the allocation of article

numbers for each product described are reserved. In particular, we do not guarantee the complete consistency of the illustrations with the product. Claims for compensation due to printing errors or other incorrect and/or incomplete information are excluded, unless we are liable for intent or gross negligence or damages are due for bodily injury, loss of life or damage to the health of a person. The reproduction of genuine part numbers or competitor article numbers is for the purposes of comparison only. The ar-

ticle numbers listed in this catalogue are the intellectual property of Herth+Buss Fahrzeugteile GmbH & Co. KG. Furthermore, we retain all rights for the documents. Reproduction, even in part, is only permitted with our prior written permission. The products supplied by us may only be used for their intended purpose. Fitting must only be performed by trained specialists.





# Clamps



# Clamps



Assortment, fasteners	109 - 112
Blind Rivet	16 - 82
Clip	15 - 86
Expanding Rivet	16 - 86
Grommet	24 - 82
Holding Bracket	17 - 86
Rivet	20 - 73
Screw	30 - 85



# Clip

## ClipFix – Effortless fixing!

There are different clips for many areas on the vehicle which secure the connection between the body and panelling, for example on panelling in the boot, in the vehicle's interior, such as the door panelling, in the engine bay, clips for sidebars etc. The product group ClipFix offers an extensive range, which includes clips,

blind rivets, retaining clips, expanding rivets, screws and other fixing parts. We also offer various ClipFix assortments. Depending on the equipment variant, these contain up to 240 parts and fit vehicles from BMW, Mercedes-Benz, VAG, Ford or Vauxhall (Opel).





## ALFA ROMEO

## ClipFix

## Clip



for OE number: 4 274 360

Diameter mm	Pitch circle Ø mm	Height 1 / 2 mm	Version	DU	Article no.
15	6,5	17 / 19	Fiat Alfa Romeo Lancia Iveco	25	50267148

## ClipFix

## Clip

for OE number: 4 292 906  
17887787

Diameter mm	Pitch circle Ø mm	Height 1 / 2 mm	Version	Fitting Position	DU	Article no.
16	8	17 / 19	Fiat Alfa Romeo Lancia Iveco	Wheel Side Interior Trim	25	50267081

## ClipFix

## Clip

for OE number: 14591987  
17887387

Diameter mm	Pitch circle Ø mm	Height 1 / 2 mm	Version	Fitting Position	DU	Article no.
20	6,5	17 / 19	Iveco Lancia Fiat Alfa Romeo	Interior Trim Wheel Side	25	50267012

## ClipFix

## Clip

for OE number: 14593487  
82450771

Diameter mm	Pitch circle Ø mm	Height 1 / 2 mm	Version	Fitting Position	DU	Article no.
24	8	17 / 19	Alfa Romeo Fiat Lancia	Interior Trim	25	50267011

## ClipFix

## Clip



for OE number: 7 6778 65

Diameter mm	Pitch circle Ø mm	Height 1 / 2 mm	Version	Fitting Position	DU	Article no.
14	6	10 / 12	Alfa Romeo Lancia Fiat	Bonnet Interior Trim Vehicle Door Wheel Side	25	50267087



## ClipFix

### Clip



for OE number: 1 020 732  
500326189

Diameter mm	Pitch circle Ø mm	Height 1 / 2 mm	Version	Fitting Position	DU	Article no.
19	8 to 8,4	15 / 21,5	Ford Alfa Romeo Lancia Iveco Fiat	Interior Trim	25	<b>50267150</b>

## ClipFix

### Expanding Rivet



for OE number: 17 19 245  
90138810  
51751429  
94530507

Diameter mm	Pitch circle Ø mm	Height 1 / 2 mm	Version	Fitting Position	DU	Article no.
16	8	11 / 21	Opel Saab Fiat Alfa Romeo Daewoo Chevrolet	Wheel Side Interior Trim	25	<b>50267001</b>

## ClipFix

### Expanding Rivet



for OE number: 1 009 164  
000 990 55 92  
90 116 376  
N 10219501  
3923475  
500355891

Diameter mm	Pitch circle Ø mm	Height 1 / 2 mm	Version	DU	Article no.	
16	5,5 to 6,4	11 / 18,5	Ford Mercedes-Benz Opel VAG Volvo Fiat Alfa Romeo Lancia Iveco		25	<b>50267147</b>

## ClipFix

### Blind Rivet



for OE number: 7 000 412  
14415890

Diameter mm	Pitch circle Ø mm	Height 1 / 2 mm	Version	Fitting Position	DU	Article no.
10	4,8	21 / 57	Ford Fiat Alfa Romeo	Bumper	25	<b>50267089</b>





BMW

**ClipFix**

Clip



for OE number: 51 41 8 224 768 Info: with seal

Diameter mm	Pitch circle Ø mm	Height 1 / 2 mm	Version	Fitting Position	DU	Article no.
18	7,9 to 8,2	14 / 20,5	BMW	Interior Trim	25	50267009

**ClipFix**

Clip



for OE number: 51 41 8 224 781 Info: with seal

Diameter mm	Pitch circle Ø mm	Height 1 / 2 mm	Version	Fitting Position	DU	Article no.
18	8	13 / 21	BMW	Vehicle Door Dashboard Interior Trim	25	50267010

**ClipFix**

Clip



for OE number: 07 14 7 145 753 Info: with seal

Diameter mm	Pitch circle Ø mm	Height 1 / 2 mm	Version	Fitting Position	DU	Article no.
18	8	10 / 17	BMW Mini	Sidewall Interior Trim	 25	50267096

**ClipFix**

Holding Bracket



for OE number: 51 71 8 108 613

Width mm	Height mm	Depth mm	Version	Fitting Position	DU	Article no.
11	14	14	BMW	Radiator Core	25	50267031

**ClipFix**

Clip



for OE number: 51 41 8 172 050

Diameter mm	Height 1 / 2 mm	Version	Fitting Position	DU	Article no.
18	14 / 21,5	BMW	Vehicle Door Dashboard	 25	50267126



## ClipFix

### Clip



for OE number: 51 41 1 870 718

Diameter mm	Pitch circle Ø mm	Height 1 / 2 mm	Version	Fitting Position	DU	Article no.
18	8	10,5 / 17	BMW	Vehicle Door Dashboard	25	<b>50267034</b>

## ClipFix

### Clip



for OE number: 51 41 1 973 500

Diameter mm	Pitch circle Ø mm	Height 1 / 2 mm	Version	Fitting Position	DU	Article no.
21	8	14 / 18	BMW	Vehicle Door Dashboard Interior Trim	25	<b>50267037</b>

## ClipFix

### Clip



for OE number: 51 47 1 840 960

Width mm	Height mm	Depth mm	Version	Fitting Position	DU	Article no.
12	8,5	9	BMW	Vehicle Door	25	<b>50267072</b>

## ClipFix

### Clip



for OE number: 51 47 1 904 317  
000 988 03 28  
N 90201601H  
2 207 713  
6 998 849

Diameter mm	Pitch circle Ø mm	Height 1 / 2 mm	Version	Fitting Position	DU	Article no.
20	8	20 / 23	BMW Mercedes-Benz VAG Opel Ford	Vehicle Door Dashboard Interior Trim Boot	25	<b>50267036</b>

## ClipFix

### Expanding Rivet



for OE number: 161 867 299 01C  
1 104 880  
6136889  
51 47 1 916 670

Diameter mm	Pitch circle Ø mm	Height 1 / 2 mm	Version	Fitting Position	DU	Article no.
16	8	11,5 / 24	VAG Opel Ford BMW	Vehicle Hatch Door Bumper Interior Trim <span style="color: red; font-weight: bold;">NEW</span>	25	<b>50267080</b>



**ClipFix**  
Expanding Rivet



for OE number: 199 016 92 92  
1 104 882  
51 47 8 170 166

Diameter mm	Pitch circle Ø mm	Height 1 / 2 mm	Version	Fitting Position	DU	Article no.
19	8	15 / 29	Mercedes-Benz Opel BMW	Wheel Side Vehicle Door	25	<b>50267014</b>

**ClipFix**  
Expanding Rivet



for OE number: 17 11 1 712 963

Diameter mm	Pitch circle Ø mm	Height 1 / 2 mm	Version	Fitting Position	DU	Article no.
15	8	10,5 / 24,5	BMW	Interior Trim	25	<b>50267016</b>

**ClipFix**  
Expanding Rivet



for OE number: 51 16 1 881 149  
N 10259301  
000 990 34 92  
6972.10  
7703072116

Diameter mm	Pitch circle Ø mm	Height 1 / 2 mm	Version	Fitting Position	DU	Article no.
10	5,5	11,5 / 23,5	BMW VAG Mercedes-Benz Peugeot Citroen Renault	Interior Trim Wheel Side	25	<b>50267017</b>

**ClipFix**  
Expanding Rivet



for OE number: 51 11 1 964 186

Diameter mm	Pitch circle Ø mm	Height 1 / 2 mm	Version	Fitting Position	DU	Article no.
15	6	20 / 42	BMW	Wheel Side	25	<b>50267033</b>



### ClipFix

Rivet



for OE number: 51 13 1 885 399 Pitch circle Ø: 7 mm  
Bolt Head-/Nut Design: Cross Head

Width mm	Height 1 / 2 mm	Depth mm	Version	Fitting Position	DU	Article no.
15	14 / 30	8	BMW	Radiator Core	25	50267035

### ClipFix

Rivet



for OE number: 51 71 8 229 000 Bolt Head-/Nut Design: Cross Head  
1382745

Diameter mm	Pitch circle Ø mm	Height 1 / 2 mm	Version	DU	Article no.
16	12	12,5 / 30	BMW Ford	25	50267184

### ClipFix

Rivet



for OE number: 51 48 1 915 964 Bolt Head-/Nut Design: Cross Head

Diameter mm	Pitch circle Ø mm	Height 1 / 2 mm	Version	Fitting Position	DU	Article no.
20	7	11 / 20	BMW	Bumper	25	50267120

### ClipFix

Expanding Rivet



for OE number: N 105 835 01 9B9  
51 49 8 166 702

Diameter mm	Pitch circle Ø mm	Height 1 / 2 mm	Version	DU	Article no.
17	7,8 to 8,8	12,3 / 27,5	VAG BMW	25	50267191

### ClipFix

Expanding Rivet



for OE number: 51 47 1 911 992  
201 990 02 92

Diameter mm	Pitch circle Ø mm	Height 1 / 2 mm	Version	Fitting Position	DU	Article no.
20	8	14 / 28	BMW Mercedes-Benz	Interior Trim	25	50267038



### ClipFix

Expanding Rivet



for OE number: 51 48 1 938 725

Diameter mm	Pitch circle Ø mm	Height 1 / 2 mm	Version	Fitting Position	DU	Article no.
19	6,2	9 / 18	BMW Mini	Vehicle Door Dashboard 	25	50267116

### ClipFix

Expanding Rivet



for OE number: 51 11 1 944 537

Diameter mm	Pitch circle Ø mm	Height 1 / 2 mm	Version	Fitting Position	DU	Article no.
20	6,5	15,5 / 30	BMW	Bumper	25	50267040

### ClipFix

Expanding Rivet



for OE number: 51 11 1 908 077  
N90 359 101  
A 000 990 54 92

Diameter mm	Pitch circle Ø mm	Height 1 / 2 mm	Version	Fitting Position	DU	Article no.
15	6,5	15,5 / 31,5	BMW VW Mercedes-Benz	Interior Trim Radiator Core Bonnet air scoop Bumper	25	50267041

### ClipFix

Expanding Rivet



for OE number: 51 11 8 174 185

Diameter mm	Pitch circle Ø mm	Height 1 / 2 mm	Version	Fitting Position	DU	Article no.
20	6,5	15 / 32	BMW	Bumper	25	50267042

### ClipFix

Clip



for OE number: 003 990 02 51 Port Thread: M5  
16 13 1 176 747

Diameter mm	Height 1 / 2 mm	Bore Ø mm	Version	DU	Article no.
16	8 / 11	5	Mercedes-Benz BMW	25	50267020



### ClipFix

Clip



for OE number: 201 990 00 50 Port Thread: M5  
51 71 1 958 025

Diameter mm	Height 1 / 2 mm	Bore Ø mm	Version	DU	Article no.
24	8 / 10,5	5	Mercedes-Benz BMW	25	<b>50267023</b>

### ClipFix

Clip



for OE number: 51 14 1 807 495

Diameter mm	Inner diameter mm	Height mm	Version	DU	Article no.
9	4	7	BMW	25	<b>50267030</b>

### ClipFix

Holding Bracket



for OE number: 51 13 2 251 394

Width mm	Height mm	Depth mm	Version	Fitting Position	DU	Article no.
31	25,5	28	BMW	Sidewall	25	<b>50267004</b>

### ClipFix

Holding Bracket



for OE number: 51 13 1 829 904

Pitch circle Ø mm	Width mm	Height mm	Depth mm	Version	DU	Article no.
8,2	28	21	21	BMW	25	<b>50267029</b>

### ClipFix

Holding Bracket



for OE number: 51 13 1 946 258 Pitch circle Ø: 6,7 mm

Width mm	Height mm	Depth mm	Version	Fitting Position	DU	Article no.
20	17	13	BMW	Vehicle Door	 25	<b>50267175</b>

### ClipFix

Holding Bracket



for OE number: 51 13 1 960 054 Pitch circle Ø: 9 mm

Width mm	Height mm	Depth mm	Version	Fitting Position	DU	Article no.
35	22	22	BMW	Sidewall	25	<b>50267032</b>



**ClipFix**  
Holding Bracket



for OE number: 51 71 2 234 032

Width mm	Height mm	Depth mm	Version	Fitting Position		DU	Article no.
32	17,5	20	BMW	Vehicle Door		25	50267109

**ClipFix**  
Holding Bracket



for OE number: 07 12 9 925 738  
211 837 223

Width mm	Height mm	Depth mm	Bore Ø mm	Version	DU	Article no.
24,5	4	11	4,2	BMW Opel VAG Ford	25	50267073

**ClipFix**  
Holding Bracket



for OE number: 51 48 8 181 420  
06725950

Diameter mm	Pitch circle Ø mm	Height 1 / 2 mm	Version	Fitting Position		DU	Article no.
17,5	8,5	13 / 15	BMW Ford	Boot		25	50267092

**ClipFix**  
Holding Bracket



for OE number: 51 31 8 177 850 Info: with adhesive film

Width mm	Height mm	Depth mm	Version	Fitting Position		DU	Article no.
56	11	13	BMW	Vehicle Windscreen		25	50267097

**ClipFix**  
Clip



for OE number: 51 32 1 938 884 ALR1051 Info: with bracket

Width mm	Height mm	Depth mm	Version	Fitting Position		DU	Article no.
29	38	14	BMW Mini Land Rover	Window Fitting		25	50267161

**ClipFix**  
Expanding Rivet



for OE number: 63 17 1 367 868 Inner diameter: 3 mm  
000 988 16 25

Pitch circle Ø mm	Width mm	Height mm	Depth mm	Version		DU	Article no.
7	10	15	10	BMW Mercedes-Benz		25	50267171



### ClipFix

#### Grommet



for OE number: 51 71 1 932 996 Diameter: 12 mm

Inner diameter mm	Pitch circle Ø mm	Height 1 / 2 mm	Version	Fitting Position	DU	Article no.
4,5	8,9 to 9,3	6,7 / 8	BMW	Interior Trim		25 50267172

### ClipFix

#### Grommet



for OE number: 51 13 1 934 160 Diameter: 10,5 mm

Inner diameter mm	Pitch circle Ø mm	Height 1 / 2 mm	Version	Fitting Position	DU	Article no.
5	8	5 / 6,5	BMW	Vehicle Door		25 50267128

### ClipFix

#### Clip



for OE number: 51 71 1 916 197

Diameter mm	Height mm	Version	DU	Article no.
19	32	BMW		25 50267189

### ClipFix

#### Holding Bracket



for OE number: 25 11 7 571 899

Wall thickness mm	Width mm	Height mm	Depth mm	Version	DU	Article no.
0,6 to 1,2	22	5	19	BMW		25 50267193

### ClipFix

#### Holding Bracket



for OE number: 51 31 7 064 098

Width mm	Height mm	Depth mm	Version	Fitting Position	DU	Article no.
40	9	11	BMW	Vehicle Windscreen		25 50267102

### ClipFix

#### Holding Bracket



for OE number: 51 41 6 654 189  
N 0143893  
0 537 655  
3 104 426

Width mm	Height mm	Depth mm	Bore Ø mm	Version	DU	Article no.
15,75	15,65	9,3	8	BMW VAG Ford Volvo		25 50267168





**ClipFix**  
Blind Rivet

for OE number: 51 71 7 002 953



Diameter mm	Pitch circle Ø mm	Height 1 / 2 mm	Version	Fitting Position	DU	Article no.
20	6	18 / 53	BMW	Wheel Side	25	<b>50267039</b>

**ClipFix**  
Blind Rivet

for OE number: 07 14 9 140 786



Diameter mm	Pitch circle Ø mm	Height mm	Version		DU	Article no.
16,9	6,3 to 6,5	58	BMW		25	<b>50267179</b>

**ClipFix**  
Blind Rivet

for OE number: 07 14 2 151 750



Diameter mm	Pitch circle Ø mm	Height mm	Version		DU	Article no.
16,9	6,3 to 6,5	56	BMW		25	<b>50267180</b>



# CHEVROLET

## ClipFix

### Expanding Rivet

for OE number:

17 19 245  
90138810  
51751429  
94530507



Diameter mm	Pitch circle Ø mm	Height 1 / 2 mm	Version	Fitting Position	DU	Article no.
16	8	11 / 21	Opel Saab Fiat Alfa Romeo Daewoo Chevrolet	Wheel Side Interior Trim	25	<b>50267001</b>



## CITROËN

## ClipFix

## Clip



for OE number: 7518.N8  
77 03 077 225

Diameter mm	Pitch circle Ø mm	Height 1 / 2 mm	Version	Fitting Position	DU	Article no.
35	8	22,5 / 25	Peugeot Citroen Renault	Wheel Side	25	50267006

## ClipFix

## Clip



for OE number: 23 46 824  
8964.81

Diameter mm	Pitch circle Ø mm	Height 1 / 2 mm	Version	Fitting Position	DU	Article no.
14	6,5	15,5 / 17,50	Opel Citroen Peugeot	Interior Trim	25	50267008

## ClipFix

## Clip



for OE number: 6995.Y5

Diameter mm	Pitch circle Ø mm	Height 1 / 2 mm	Version	Fitting Position	DU	Article no.
18	8 to 8,2	14 / 21	Citroen	Vehicle Door Dashboard Interior Trim	25	50267013

## ClipFix

## Clip



for OE number: 8565.40  
7701049270  
007 173 79 18

Diameter mm	Pitch circle Ø mm	Height 1 / 2 mm	Version	Fitting Position	DU	Article no.
20	8,5	10 / 16	Peugeot Citroen Renault Fiat	Sidewall Skid Plate Bonnet	25	50267129

## ClipFix

## Clip



for OE number: 8123.96 Info: with seal

Diameter mm	Height 1 / 2 mm	Version	Fitting Position	DU	Article no.
18	11 / 19	Citroen	Interior Trim Vehicle Windscreen	25	50267121



## ClipFix

### Clip



for OE number: 6995.W1

Diameter mm	Pitch circle Ø mm	Height 1 / 2 mm	Version	Fitting Position	DU	Article no.
21	8	18 / 21	Peugeot Citroen	Interior Trim	25	50267186

## ClipFix

### Expanding Rivet



for OE number: 51 16 1 881 149  
N 10259301  
000 990 34 92  
6972.10  
7703072116

Diameter mm	Pitch circle Ø mm	Height 1 / 2 mm	Version	Fitting Position	DU	Article no.
10	5,5	11,5 / 23,5	BMW VAG Mercedes-Benz Peugeot Citroen Renault	Interior Trim Wheel Side	25	50267017

## ClipFix

### Expanding Rivet



for OE number: 113 857 117 B  
6972.07

Diameter mm	Pitch circle Ø mm	Height 1 / 2 mm	Version	Fitting Position	DU	Article no.
8	3,5	8,2 / 14	VAG Peugeot Citroen	Interior Trim	25	50267018

## ClipFix

### Expanding Rivet



for OE number: 123 990 02 92  
7813.24

Diameter mm	Pitch circle Ø mm	Height 1 / 2 mm	Version	Fitting Position	DU	Article no.
20	8 to 8,2	10 / 20	Mercedes-Benz Citroen Peugeot	Radiator Core	25	50267082

## ClipFix

### Clip



for OE number: 6997.86 Pitch circle Ø: 4 mm  
7701044547  
9619769080

Width mm	Height 1 / 2 mm	Depth mm	Version	Fitting Position	DU	Article no.
17	10 / 11,5	8	Peugeot Citroen Renault	Vehicle Door	25	50267086

**ClipFix**

## Clip

for OE number: 6999.T4  
9605146380

Diameter mm	Pitch circle Ø mm	Height 1 / 2 mm	Version	Fitting Position	DU	Article no.
12	5	10 / 12	Peugeot Citroen Fiat	Vehicle Door Interior Trim	25	<b>50267130</b>

**ClipFix**

## Expanding Rivet

for OE number: 6991.X7  
999 507 497 40

Diameter mm	Pitch circle Ø mm	Height 1 / 2 mm	Version	Fitting Position	DU	Article no.
20	8	14 / 35	Peugeot Citroen Porsche	Wheel Side	25	<b>50267131</b>

**ClipFix**

## Expanding Rivet

for OE number: 000 990 22 92  
7903072116  
08968165  
7703072173  
947098

Diameter mm	Pitch circle Ø mm	Height 1 / 2 mm	Version	DU	Article no.
10	5 to 5,2	7,5 / 19	Mercedes-Benz Citroen Peugeot Opel Renault Volvo	25	<b>50267170</b>

**ClipFix**

## Expanding Rivet

for OE number: 6972.24  
001 990 24 92  
77 03 072 224

Diameter mm	Pitch circle Ø mm	Height 1 / 2 mm	Version	DU	Article no.
8	4 to 4,2	8,5 / 16,5	Peugeot Citroen Mercedes-Benz Renault	25	<b>50267183</b>

**ClipFix**

## Rivet

for OE number: 77 03 072 327 Bolt Head-/Nut Design: Torx  
963 338 87 80

Diameter mm	Pitch circle Ø mm	Height 1 / 2 mm	Version	DU	Article no.
9,8	6,2	9 / 21	Renault Peugeot Citroen	25	<b>50267188</b>



1

## ClipFix

Clip



for OE number: 8964.57  
90431553

Diameter mm	Pitch circle Ø mm	Height 1 / 2 mm	Version	DU	Article no.
14	7,2 to 7,6	16 / 18	Peugeot Citroen Opel	25	50267192

## ClipFix

Clip



for OE number: 6995.15  
7703077066

Diameter mm	Pitch circle Ø mm	Height 1 / 2 mm	Version	DU	Article no.
12,5	6,5	17,2 / 19	Peugeot Citroen Renault	25	50267185

## ClipFix

Clip



for OE number: 6992.95

Diameter mm	Pitch circle Ø mm	Height 1 / 2 mm	Version	DU	Article no.
18	6,5	16,5 / 18,3	Citroen Peugeot	25	50267145

## ClipFix

Screw



for OE number: 7030.16 Bolt Head-/Nut Design: Slot

Diameter mm	Pitch circle Ø mm	Height 1 / 2 mm	Version	DU	Article no.
11	6,5	19,5 / 24	Peugeot Citroen	25	50267106

## ClipFix

Holding Bracket



for OE number: 7030.18

Width mm	Height mm	Depth mm	Bore Ø mm	Version	DU	Article no.
23	10	12	6	Peugeot Citroen	25	50267107
<b>Accessories</b>				see	DU	
Screw ClipFix				Page 30	25	50267106



## DACIA

## ClipFix

## Clip



for OE number: 77 03 077 435

Diameter mm	Pitch circle Ø mm	Height 1 / 2 mm	Version	Fitting Position	DU	Article no.
35,5	10,5	22,5 / 25,5	Renault Dacia	Wheel Side Bumper	25	<b>50267005</b>

## DAEWU

## ClipFix

## Expanding Rivet

for OE number: 17 19 245  
90138810  
51751429  
94530507

Diameter mm	Pitch circle Ø mm	Height 1 / 2 mm	Version	Fitting Position	DU	Article no.
16	8	11 / 21	Opel Saab Fiat Alfa Romeo Daewoo Chevrolet	Wheel Side Interior Trim	25	<b>50267001</b>

## ClipFix

## Clip



for OE number: 23 45 957

Diameter mm	Pitch circle Ø mm	Height 1 / 2 mm	Version	Fitting Position	DU	Article no.
17	8	13 / 18	Opel Daewoo	Vehicle Door Dashboard Interior Trim	 25	<b>50267093</b>



# FIAT

## ClipFix

Clip



for OE number: 14593487  
82450771

Diameter mm	Pitch circle Ø mm	Height 1 / 2 mm	Version	Fitting Position	DU	Article no.
24	8	17 / 19	Alfa Romeo Fiat Lancia	Interior Trim	25	<b>50267011</b>

## ClipFix

Clip



for OE number: 14591987  
17887387

Diameter mm	Pitch circle Ø mm	Height 1 / 2 mm	Version	Fitting Position	DU	Article no.
20	6,5	17 / 19	Iveco Lancia Fiat Alfa Romeo	Interior Trim Wheel Side	25	<b>50267012</b>

## ClipFix

Clip



for OE number: 4 292 906  
17887787

Diameter mm	Pitch circle Ø mm	Height 1 / 2 mm	Version	Fitting Position	DU	Article no.
16	8	17 / 19	Fiat Alfa Romeo Lancia Iveco	Wheel Side Interior Trim	 25	<b>50267081</b>

## ClipFix

Clip



for OE number: 4 274 360

Diameter mm	Pitch circle Ø mm	Height 1 / 2 mm	Version	DU	Article no.
15	6,5	17 / 19	Fiat Alfa Romeo Lancia Iveco	 25	<b>50267148</b>

## ClipFix

Expanding Rivet



for OE number: 17 19 245  
90138810  
51751429  
94530507

Diameter mm	Pitch circle Ø mm	Height 1 / 2 mm	Version	Fitting Position	DU	Article no.
16	8	11 / 21	Opel Saab Fiat Alfa Romeo Daewoo Chevrolet	Wheel Side Interior Trim	25	<b>50267001</b>





**ClipFix**  
Expanding Rivet



for OE number: 1 009 164  
000 990 55 92  
90 116 376  
N 10219501  
3923475  
500355891

Diameter mm	Pitch circle Ø mm	Height 1 / 2 mm	Version	DU	Article no.
16	5,5 to 6,4	11 / 18,5	Ford Mercedes-Benz Opel VAG Volvo Fiat Alfa Romeo Lancia Iveco	25	<b>50267147</b>

**ClipFix**  
Grommet



for OE number: 1H0 853 586

Diameter mm	Inner diameter mm	Height mm	Version	Fitting Position	DU	Article no.
13	6	12	VAG Lancia Fiat	Boot Sidewall	25	<b>50267063</b>

**ClipFix**  
Clip



for OE number: 7 6778 65

Diameter mm	Pitch circle Ø mm	Height 1 / 2 mm	Version	Fitting Position	DU	Article no.
14	6	10 / 12	Alfa Romeo Lancia Fiat	Bonnet Interior Trim Vehicle Door Wheel Side	25	<b>50267087</b>

**ClipFix**  
Blind Rivet



for OE number: 7 000 412  
14415890

Diameter mm	Pitch circle Ø mm	Height 1 / 2 mm	Version	Fitting Position	DU	Article no.
10	4,8	21 / 57	Ford Fiat Alfa Romeo	Bumper	25	<b>50267089</b>

**ClipFix**  
Holding Bracket



for OE number: 6 029 253 **Width:** 21 mm  
46473571  
46473571  
Surface: Zinc-coated

Height mm	Depth mm	Bore Ø mm	Version	Fitting Position	DU	Article no.
7	14	5	Ford Fiat	at headlight	25	<b>50267105</b>



## ClipFix

### Clip



for OE number: 8565.40  
7701049270  
007 173 79 18

Diameter mm	Pitch circle Ø mm	Height 1 / 2 mm	Version	Fitting Position	DU	Article no.
20	8,5	10 / 16	Peugeot Citroen Renault Fiat	Sidewall Skid Plate Bonnet	25	<b>50267129</b>

## ClipFix

### Clip



for OE number: 6999.T4  
9605146380

Diameter mm	Pitch circle Ø mm	Height 1 / 2 mm	Version	Fitting Position	DU	Article no.
12	5	10 / 12	Peugeot Citroen Fiat	Vehicle Door Interior Trim	25	<b>50267130</b>

## ClipFix

### Rivet



for OE number: 71 741 883  
9046707164  
09409-07332

Diameter mm	Pitch circle Ø mm	Height 1 / 2 mm	Version	Fitting Position	DU	Article no.
20	7	10 / 21	Fiat Toyota Lexus Subaru Suzuki	Wheel Side	25	<b>50267117</b>

## ClipFix

### Clip



for OE number: 1 020 732  
500326189

Diameter mm	Pitch circle Ø mm	Height 1 / 2 mm	Version	Fitting Position	DU	Article no.
19	8 to 8,4	15 / 21,5	Ford Alfa Romeo Lancia Iveco Fiat	Interior Trim	25	<b>50267150</b>



# FORD

## ClipFix

Clip



for OE number: 823 863 203 01C  
1489595

Diameter mm	Pitch circle Ø mm	Height 1 / 2 mm	Version	Fitting Position	DU	Article no.
14	6	14,5 / 17	VAG Ford	Interior Trim Vehicle Door Vehicle Hatch Door Boot Bonnet Radiator Core	25	<b>50267028</b>

## ClipFix

Clip



for OE number: 51 47 1 904 317  
000 988 03 28  
N 90201601H  
2 207 713  
6 998 849

Diameter mm	Pitch circle Ø mm	Height 1 / 2 mm	Version	Fitting Position	DU	Article no.
20	8	20 / 23	BMW Mercedes-Benz VAG Opel Ford	Vehicle Door Dashboard Interior Trim Boot	25	<b>50267036</b>

## ClipFix

Clip



for OE number: 1 257 376

Diameter mm	Pitch circle Ø mm	Height 1 / 2 mm	Version	Fitting Position	DU	Article no.
18	8	9 / 28	Ford	Interior Trim Vehicle Door Dashboard	25	<b>50267132</b>

## ClipFix

Clip



for OE number: 7M0 867 299 K  
1008068

Diameter mm	Pitch circle Ø mm	Height 1 / 2 mm	Version	Fitting Position	DU	Article no.
18	8	14 / 21	VAG Ford	Vehicle Door Dashboard	25	<b>50267050</b>

## ClipFix

Clip



for OE number: 011 988 76 78 Info: with seal  
2E1827649  
6 117 693  
M283083

Diameter mm	Pitch circle Ø mm	Height 1 / 2 mm	Version	Fitting Position	DU	Article no.
18	8,1 to 8,5	10 / 18	Mercedes-Benz VAG Ford Mitsubishi	Interior Trim	25	<b>50267141</b>



## ClipFix

### Clip



for OE number: 1 020 732  
500326189

Diameter mm	Pitch circle Ø mm	Height 1 / 2 mm	Version	Fitting Position	DU	Article no.
19	8 to 8,4	15 / 21,5	Ford Alfa Romeo Lancia Iveco Fiat	Interior Trim	25	<b>50267150</b>

## ClipFix

### Expanding Rivet



for OE number: 1 007 932 Bolt Head-/Nut Design: Cross Head

Diameter mm	Pitch circle Ø mm	Height 1 / 2 mm	Version	Fitting Position	DU	Article no.
16	6,5	18 / 25	Ford	Wheel Side	25	<b>50267002</b>

## ClipFix

### Expanding Rivet



for OE number: 8E0 825 267  
1039463  
770 104 92 71  
4803228

Diameter mm	Pitch circle Ø mm	Height 1 / 2 mm	Version	Fitting Position	DU	Article no.
20	8,5	21 / 33	VAG Ford Renault Opel	Wheel Side Skid Plate Bumper Bonnet air scoop	25	<b>50267003</b>

## ClipFix

### Expanding Rivet



for OE number: 161 867 299 01C  
1 104 880  
6136889  
51 47 1 916 670

Diameter mm	Pitch circle Ø mm	Height 1 / 2 mm	Version	Fitting Position	DU	Article no.
16	8	11,5 / 24	VAG Opel Ford BMW	Vehicle Hatch Door Bumper Interior Trim	25	<b>50267080</b>

## ClipFix

### Expanding Rivet



for OE number: N 0385501  
7 200 671

Diameter mm	Pitch circle Ø mm	Height 1 / 2 mm	Version	Fitting Position	DU	Article no.
12,5	8,5	11 / 17	VAG Ford	Bumper Wheel Side Bonnet Sidewall Wing Interior Trim Radiator Core	25	<b>50267085</b>



**ClipFix**  
Expanding Rivet



for OE number: 1 009 164  
000 990 55 92  
90 116 376  
N 10219501  
3923475  
500355891

Diameter mm	Pitch circle Ø mm	Height 1 / 2 mm	Version	DU	Article no.
16	5,5 to 6,4	11 / 18,5	Ford Mercedes-Benz Opel VAG Volvo Fiat Alfa Romeo Lancia Iveco	25	<b>50267147</b>

**ClipFix**  
Holding Bracket



for OE number: 51 48 8 181 420  
06725950

Diameter mm	Pitch circle Ø mm	Height 1 / 2 mm	Version	Fitting Position	DU	Article no.
17,5	8,5	13 / 15	BMW Ford	Boot	25	<b>50267092</b>

**ClipFix**  
Clip



for OE number: 1 042 065

Diameter mm	Pitch circle Ø mm	Height 1 / 2 mm	Version	Fitting Position	DU	Article no.
6	5	8,1 / 14	Ford	Vehicle Door	25	<b>50267099</b>

**ClipFix**  
Expanding Rivet



for OE number: 4 855 809

Diameter mm	Pitch circle Ø mm	Height 1 / 2 mm	Version	Fitting Position	DU	Article no.
18	6	17,5 / 27	Ford	Bumper Wheel Side Interior Trim	25	<b>50267112</b>

**ClipFix**  
Holding Bracket



for OE number: N 10 154 322      Width: 25 mm  
207 217 563  
1470998

Height mm	Depth mm	Bore Ø mm	Version	Fitting Position	DU	Article no.
5	16	6,3	VAG Opel Ford	Wing Interior Trim Number Plate Light	25	<b>50267122</b>



## ClipFix

### Holding Bracket



for OE number: 07 12 9 925 738  
211 837 223

Width mm	Height mm	Depth mm	Bore Ø mm	Version	DU	Article no.
24,5	4	11	4,2	BMW Opel VAG Ford	25	50267073

## ClipFix

### Holding Bracket



for OE number: 1 476 196

Width mm	Height mm	Depth mm	Bore Ø mm	Version	DU	Article no.
17	5	16	6,3	Ford	25	50267123

## ClipFix

### Holding Bracket



for OE number: 6 029 253      Width: 21 mm  
46473571  
46473571  
Surface: Zinc-coated

Height mm	Depth mm	Bore Ø mm	Version	Fitting Position	DU	Article no.
7	14	5	Ford Fiat	at headlight	25	50267105

## ClipFix

### Holding Bracket



for OE number: 6103426      Width: 25 mm  
7703046020

Height mm	Depth mm	Bore Ø mm	Version	Fitting Position	DU	Article no.
10	17	8	Renault Peugeot Ford	Vehicle Door	25	50267135

## ClipFix

### Holding Bracket



for OE number: 6 089 805      Port Thread: M8  
A 001 990 58 91

Wall thickness mm	Width mm	Height mm	Depth mm	Version	DU	Article no.
0,8 to 4	27,5	10	18	Ford Mercedes-Benz	25	50267166

## ClipFix

### Holding Bracket



for OE number: N90 335 004  
6 715 468

Diameter mm	Version	Fitting Position	DU	Article no.
30	VAG Ford	Vehicle Door Interior Trim Bonnet Bumper Skid Plate	25	50267069



### ClipFix

Clip



for OE number: 4 494 055

Width mm	Height mm	Depth mm	Version	Fitting Position		DU	Article no.
26	25	14	Ford	Vehicle Windscreen		25	50267124

### ClipFix

Holding Bracket



for OE number: 4 494 056

Width mm	Height mm	Depth mm	Version	Fitting Position		DU	Article no.
26	16	14	Ford	Vehicle Windscreen		25	50267125

### ClipFix

Clip



for OE number: 1 106 903

Pitch circle Ø mm	Width mm	Height mm	Depth mm	Version		DU	Article no.
8	46	22	23	Ford		25	50267154

### ClipFix

Blind Rivet



for OE number: 7 000 412  
14415890

Diameter mm	Pitch circle Ø mm	Height 1 / 2 mm	Version	Fitting Position		DU	Article no.
10	4,8	21 / 57	Ford Fiat Alfa Romeo	Bumper		25	50267089

### ClipFix

Blind Rivet



for OE number: 1 071 415

Diameter mm	Pitch circle Ø mm	Height 1 / 2 mm	Version	Fitting Position		DU	Article no.
16	4,8	14 / 56	Ford	Bumper		25	50267134



## ClipFix

### Clip



for OE number: 1 251 866

Width mm	Height mm	Depth mm	Version	DU	Article no.
28	17	30	Ford	25	50267151

## ClipFix

### Expanding Rivet



for OE number: 6 549 354

Width mm	Height mm	Depth mm	Bore Ø mm	Version	DU	Article no.
13	21	13	6,3	Ford	25	50267155

## ClipFix

### Clip



for OE number: 1 020 193

Width mm	Height mm	Depth mm	Version	Fitting Position	DU	Article no.
27	18	14	Ford	Interior Trim	25	50267156

## ClipFix

### Rivet



for OE number: 51 71 8 229 000 Bolt Head-/Nut Design: Cross Head  
1382745

Diameter mm	Pitch circle Ø mm	Height 1 / 2 mm	Version	DU	Article no.
16	12	12,5 / 30	BMW Ford	25	50267184

## ClipFix

### Expanding Rivet



for OE number: 1 007 902

Diameter mm	Pitch circle Ø mm	Height mm	Version	DU	Article no.
22	4,8	21	Ford	25	50267153

## ClipFix

### Holding Bracket



for OE number: 51 41 6 654 189  
N 0143893  
0 537 655  
3 104 426

Width mm	Height mm	Depth mm	Bore Ø mm	Version	DU	Article no.
15,75	15,65	9,3	8	BMW VAG Ford Volvo	25	50267168



**ClipFix****Clip**

for OE number: 1 629 082

Diameter mm	Pitch circle Ø mm	Height 1 / 2 mm	Version	DU	Article no.
18	7 to 7,4	22,1 / 24,1	Ford	25	50267176

**ClipFix****Clip**

for OE number: 1 018 435

Diameter mm	Pitch circle Ø mm	Height 1 / 2 mm	Version	DU	Article no.
18	8,4 to 8,62	15,6 / 18,1	Ford	25	50267178

**ClipFix****Rivet**

for OE number: 6 743 363 Bolt Head-/Nut Design: Cross Head

Pitch circle Ø mm	Width mm	Height 1 / 2 mm	Depth mm	Version	DU	Article no.
5,6 to 5,8	15,5	12 / 25,5	8	Ford	25	50267182



# HONDA

## ClipFix

### Expanding Rivet



for OE number:

MR 328954  
91545SE0003  
01553-09321

Diameter mm	Pitch circle Ø mm	Height 1 / 2 mm	Version	Fitting Position	DU	Article no.
20	8	12 / 21	Mitsubishi Honda Nissan	Interior Trim Bumper Wheel Side Radiator Core	25	<b>50267098</b>

## ClipFix

### Rivet



for OE number:

91503-SZ3-003

Diameter mm	Pitch circle Ø mm	Height 1 / 2 mm	Version	Fitting Position	DU	Article no.
18	10	16 / 25	Honda	Bumper	25	<b>50267110</b>



IVECO

**ClipFix**

## Clip

for OE number: 14591987  
17887387

Diameter mm	Pitch circle Ø mm	Height 1 / 2 mm	Version	Fitting Position	DU	Article no.
20	6,5	17 / 19	Iveco Lancia Fiat Alfa Romeo	Interior Trim Wheel Side	25	50267012

**ClipFix**

## Clip



for OE number: 4 274 360

Diameter mm	Pitch circle Ø mm	Height 1 / 2 mm	Version	DU	Article no.
15	6,5	17 / 19	Fiat Alfa Romeo Lancia Iveco	<b>NEW</b> 25	50267148

**ClipFix**

## Clip

for OE number: 4 292 906  
17887787

Diameter mm	Pitch circle Ø mm	Height 1 / 2 mm	Version	Fitting Position	DU	Article no.
16	8	17 / 19	Fiat Alfa Romeo Lancia Iveco	Wheel Side Interior Trim	<b>NEW</b> 25	50267081

**ClipFix**

## Clip

for OE number: 1 020 732  
500326189

Diameter mm	Pitch circle Ø mm	Height 1 / 2 mm	Version	Fitting Position	DU	Article no.
19	8 to 8,4	15 / 21,5	Ford Alfa Romeo Lancia Iveco Fiat	Interior Trim	<b>NEW</b> 25	50267150

**ClipFix**

## Expanding Rivet

for OE number: 1 009 164  
000 990 55 92  
90 116 376  
N 10219501  
3923475  
500355891

Diameter mm	Pitch circle Ø mm	Height 1 / 2 mm	Version	DU	Article no.
16	5,5 to 6,4	11 / 18,5	Ford Mercedes-Benz Opel VAG Volvo Fiat Alfa Romeo Lancia Iveco	<b>NEW</b> 25	50267147



# LANCIA

## ClipFix

### Clip



for OE number: 14593487  
82450771

Diameter mm	Pitch circle Ø mm	Height 1 / 2 mm	Version	Fitting Position	DU	Article no.
24	8	17 / 19	Alfa Romeo Fiat Lancia	Interior Trim	25	50267011

## ClipFix

### Clip



for OE number: 14591987  
17887387

Diameter mm	Pitch circle Ø mm	Height 1 / 2 mm	Version	Fitting Position	DU	Article no.
20	6,5	17 / 19	Iveco Lancia Fiat Alfa Romeo	Interior Trim Wheel Side	25	50267012

## ClipFix

### Clip



for OE number: 4 292 906  
17887787

Diameter mm	Pitch circle Ø mm	Height 1 / 2 mm	Version	Fitting Position	DU	Article no.
16	8	17 / 19	Fiat Alfa Romeo Lancia Iveco	Wheel Side Interior Trim	25	50267081

## ClipFix

### Clip



for OE number: 4 274 360

Diameter mm	Pitch circle Ø mm	Height 1 / 2 mm	Version	DU	Article no.
15	6,5	17 / 19	Fiat Alfa Romeo Lancia Iveco	25	50267148

## ClipFix

### Grommet



for OE number: 1H0 853 586

Diameter mm	Inner diameter mm	Height mm	Version	Fitting Position	DU	Article no.
13	6	12	VAG Lancia Fiat	Boot Sidewall	25	50267063

**ClipFix****Clip**

for OE number: 7 6778 65

Diameter mm	Pitch circle Ø mm	Height 1 / 2 mm	Version	Fitting Position	DU	Article no.
14	6	10 / 12	Alfa Romeo Lancia Fiat	Bonnet Interior Trim Vehicle Door Wheel Side		25 <b>50267087</b>

**ClipFix****Clip**for OE number: 1 020 732  
500326189

Diameter mm	Pitch circle Ø mm	Height 1 / 2 mm	Version	Fitting Position	DU	Article no.
19	8 to 8,4	15 / 21,5	Ford Alfa Romeo Lancia Iveco Fiat	Interior Trim		25 <b>50267150</b>

**ClipFix****Expanding Rivet**for OE number: 1 009 164  
000 990 55 92  
90 116 376  
N 10219501  
3923475  
500355891

Diameter mm	Pitch circle Ø mm	Height 1 / 2 mm	Version	DU	Article no.
16	5,5 to 6,4	11 / 18,5	Ford Mercedes-Benz Opel VAG Volvo Fiat Alfa Romeo Lancia Iveco		25 <b>50267147</b>



# LEXUS

## ClipFix

### Clip



for OE number: 90189-06013 Diameter: 20 mm

Pitch circle Ø mm	Height 1 / 2 mm	Bore Ø mm	Version	Fitting Position	DU	Article no.
8	18 / 19	5,5	Toyota Lexus	Interior Trim	25	<b>50267104</b>

## ClipFix

### Rivet



for OE number: 90467-10183

Diameter mm	Pitch circle Ø mm	Height 1 / 2 mm	Version	Fitting Position	DU	Article no.
18	7	7,5 / 17	Lexus Toyota	Wheel Side	25	<b>50267111</b>

## ClipFix

### Rivet



for OE number: 71 741 883  
9046707164  
09409-07332

Diameter mm	Pitch circle Ø mm	Height 1 / 2 mm	Version	Fitting Position	DU	Article no.
20	7	10 / 21	Fiat Toyota Lexus Subaru Suzuki	Wheel Side	25	<b>50267117</b>

## ClipFix

### Clip



for OE number: 90467-10161

Diameter mm	Pitch circle Ø mm	Height 1 / 2 mm	Version	Fitting Position	DU	Article no.
19	8	13 / 20	Toyota Lexus	Interior Trim	25	<b>50267127</b>



MAZDA

**ClipFix**

Rivet

for OE number:

NA01-56-145  
63844-01A00

Bolt Head-/Nut Design:

Cross Head



Diameter mm	Pitch circle Ø mm	Height 1 / 2 mm	Version	Fitting Position	DU	Article no.
20	7,5	18,5 / 27	Mazda Nissan	Wheel Side	 25	<b>50267108</b>

**ClipFix**

Rivet

for OE number:

BC1D-56-145



Diameter mm	Height 1 / 2 mm	Version	Fitting Position	DU	Article no.
20	12 / 21	Mazda	Wheel Side Bumper	 25	<b>50267137</b>



# MERCEDES-BENZ

## ClipFix Holding Bracket



for OE number: 001 988 49 81 Pitch circle Ø: 6 mm

Width mm	Height mm	Depth mm	Version	Fitting Position	DU	Article no.
16	22	16	Mercedes-Benz	Sidewall	25	50267024

## ClipFix Clip



for OE number: 398 841 78 78

Diameter mm	Pitch circle Ø mm	Height 1 / 2 mm	Version	Fitting Position	DU	Article no.
18	8	10 / 16	Mercedes-Benz	Vehicle Door Dashboard	25	50267025

## ClipFix Clip



for OE number: 4D0 867 299 A  
A 005 988 82 78

Diameter mm	Pitch circle Ø mm	Height 1 / 2 mm	Version	Fitting Position	DU	Article no.
18	7,9 to 8	10 / 16,5	VAG Mercedes-Benz	Interior Trim	25	50267142

## ClipFix Clip



for OE number: 011 988 76 78 Info: with seal  
2E1827649  
6 117 693  
M283083

Diameter mm	Pitch circle Ø mm	Height 1 / 2 mm	Version	Fitting Position	DU	Article no.
18	8,1 to 8,5	10 / 18	Mercedes-Benz VAG Ford Mitsubishi	Interior Trim	25	50267141

## ClipFix Clip



for OE number: 008 988 09 78

Diameter mm	Pitch circle Ø mm	Height 1 / 2 mm	Version	Fitting Position	DU	Article no.
18	8,5	13 / 19,5	Mercedes-Benz	Interior Trim	25	50267071





**ClipFix**  
**Grommet**

for OE number: 001 988 76 81



Diameter mm	Pitch circle Ø mm	Height 1 / 2 mm	Version	Fitting Position	DU	Article no.
7	5,5	7 / 9	Mercedes-Benz	Sidewall	25	<b>50267026</b>

**ClipFix**  
**Grommet**

for OE number: 001 988 20 81 Diameter: 11 mm



Inner diameter mm	Pitch circle Ø mm	Height 1 / 2 mm	Version	Fitting Position	DU	Article no.
4	9	13 / 14	Mercedes-Benz	Sidewall	25	<b>50267022</b>

**ClipFix**  
**Grommet**

for OE number: 201 997 22 81



Diameter mm	Inner diameter mm	Pitch circle Ø mm	Height 1 / 2 mm	Version	DU	Article no.
7	3,55	5,7 to 5,8	6,1 / 7	Mercedes-Benz	 25	<b>50267177</b>

**ClipFix**  
**Grommet**

for OE number: 000 988 15 81



Diameter mm	Inner diameter mm	Pitch circle Ø mm	Height 1 / 2 mm	Version	DU	Article no.
10	4	8,5 to 9	6,5 / 8	Mercedes-Benz	 25	<b>50267076</b>

**ClipFix**  
**Clip**

for OE number: 51 47 1 904 317  
000 988 03 28  
N 90201601H  
2 207 713  
6 998 849



Diameter mm	Pitch circle Ø mm	Height 1 / 2 mm	Version	Fitting Position	DU	Article no.
20	8	20 / 23	BMW Mercedes-Benz VAG Opel Ford	Vehicle Door Dashboard Interior Trim Boot	25	<b>50267036</b>



## ClipFix

### Expanding Rivet



for OE number: 199 016 92 92  
1 104 882  
51 47 8 170 166

Diameter mm	Pitch circle Ø mm	Height 1 / 2 mm	Version	Fitting Position	DU	Article no.
19	8	15 / 29	Mercedes-Benz Opel BMW	Wheel Side Vehicle Door	25	<b>50267014</b>

## ClipFix

### Expanding Rivet



for OE number: 171 885 767  
001 994 41 45

Diameter mm	Pitch circle Ø mm	Height 1 / 2 mm	Version	Fitting Position	DU	Article no.
18	7,5	17 / 27	VAG Mercedes-Benz	Vehicle Hatch Door Interior Trim	25	<b>50267015</b>

## ClipFix

### Expanding Rivet



for OE number: 51 16 1 881 149  
N 10259301  
000 990 34 92  
6972.10  
7703072116

Diameter mm	Pitch circle Ø mm	Height 1 / 2 mm	Version	Fitting Position	DU	Article no.
10	5,5	11,5 / 23,5	BMW VAG Mercedes-Benz Peugeot Citroen Renault	Interior Trim Wheel Side	25	<b>50267017</b>

## ClipFix

### Expanding Rivet



for OE number: 1 009 164  
000 990 55 92  
90 116 376  
N 10219501  
3923475  
500355891

Diameter mm	Pitch circle Ø mm	Height 1 / 2 mm	Version	DU	Article no.
16	5,5 to 6,4	11 / 18,5	Ford Mercedes-Benz Opel VAG Volvo Fiat Alfa Romeo Lancia Iveco	 25	<b>50267147</b>



**ClipFix**  
Expanding Rivet



for OE number: 000 990 22 92  
7903072116  
08968165  
7703072173  
947098

Diameter mm	Pitch circle Ø mm	Height 1 / 2 mm	Version	DU	Article no.
10	5 to 5,2	7,5 / 19	Mercedes-Benz Citroen Peugeot Opel Renault Volvo	 25	<b>50267170</b>

**ClipFix**  
Expanding Rivet



for OE number: 000 990 37 92  
N10032301  
90356928

Diameter mm	Pitch circle Ø mm	Height 1 / 2 mm	Version	DU	Article no.
13	8 to 8,6	15 / 32	Mercedes-Benz VAG Opel	 25	<b>50267174</b>

**ClipFix**  
Expanding Rivet



for OE number: 6972.24  
001 990 24 92  
77 03 072 224

Diameter mm	Pitch circle Ø mm	Height 1 / 2 mm	Version	DU	Article no.
8	4 to 4,2	8,5 / 16,5	Peugeot Citroen Mercedes-Benz Renault	 25	<b>50267183</b>

**ClipFix**  
Holding Bracket



for OE number: 124 990 07 92

Width mm	Height mm	Depth mm	Version	Fitting Position	DU	Article no.
11	22	14	Mercedes-Benz	Interior Trim	25	<b>50267019</b>

**ClipFix**  
Expanding Rivet



for OE number: 51 47 1 911 992  
201 990 02 92

Diameter mm	Pitch circle Ø mm	Height 1 / 2 mm	Version	Fitting Position	DU	Article no.
20	8	14 / 28	BMW Mercedes-Benz	Interior Trim	25	<b>50267038</b>



1

## ClipFix

Expanding Rivet



for OE number: 51 11 1 908 077  
N90 359 101  
A 000 990 54 92

Diameter mm	Pitch circle Ø mm	Height 1 / 2 mm	Version	Fitting Position	DU	Article no.
15	6,5	15,5 / 31,5	BMW VW Mercedes-Benz	Interior Trim Radiator Core Bonnet air scoop Bumper	25	50267041

## ClipFix

Expanding Rivet



for OE number: 123 990 02 92  
7813.24

Diameter mm	Pitch circle Ø mm	Height 1 / 2 mm	Version	Fitting Position	DU	Article no.
20	8 to 8,2	10 / 20	Mercedes-Benz Citroen Peugeot	Radiator Core	25	50267082

## ClipFix

Expanding Rivet



for OE number: 123 990 00 92  
333 867 633 4FB

Diameter mm	Pitch circle Ø mm	Height 1 / 2 mm	Version	Fitting Position	DU	Article no.
14	8	11 / 23	Mercedes-Benz VAG	Vehicle Hatch Door Boot Bonnet	25	50267078

## ClipFix

Expanding Rivet



for OE number: 001 990 13 92

Diameter mm	Pitch circle Ø mm	Height 1 / 2 mm	Version	DU	Article no.
15	4,55 to 5,15	11,5 / 24,5	Mercedes Benz	25	50267199

## ClipFix

Expanding Rivet



for OE number: 124 990 04 92

Diameter mm	Pitch circle Ø mm	Height 1 / 2 mm	Version	DU	Article no.
15	7	17 / 31	Mercedes-Benz	25	50267196

**ClipFix**

Screw

for OE number: 140 671 00 78



Pitch circle Ø mm	Height mm	Version	DU	Article no.
4,8	23,3	Mercedes-Benz	25	50267157

**ClipFix**

Rivet

for OE number: 000 990 46 92



Diameter mm	Pitch circle Ø mm	Height 1 / 2 mm	Version	DU	Article no.
17	6,2	14,5 / 28	Mercedes-Benz	25	50267169

**ClipFix**

Rivet

for OE number: 000 990 40 92 Bolt Head-/Nut Design: Cross Head



Diameter mm	Pitch circle Ø mm	Height 1 / 2 mm	Version	DU	Article no.
12	4,8 to 5,2	11 / 24,5	Mercedes-Benz	25	50267173

**ClipFix**

Clip

for OE number: 003 990 02 51 Port Thread: M5  
16 13 1 176 747

Diameter mm	Height 1 / 2 mm	Bore Ø mm	Version	DU	Article no.
16	8 / 11	5	Mercedes-Benz BMW	25	50267020

**ClipFix**

Clip

for OE number: 201 990 00 50 Port Thread: M5  
51 71 1 958 025

Diameter mm	Height 1 / 2 mm	Bore Ø mm	Version	DU	Article no.
24	8 / 10,5	5	Mercedes-Benz BMW	25	50267023

**ClipFix**

Holding Bracket

for OE number: 001 988 51 81



Width mm	Height mm	Depth mm	Version	Fitting Position	DU	Article no.
24	15	14	Mercedes-Benz	Sidewall	25	50267021



### ClipFix

Holding Bracket



for OE number: 006 988 30 78

Width mm	Height mm	Depth mm	Version	Fitting Position	DU	Article no.
22	16	17	Mercedes-Benz	Sidewall	25	50267070

### ClipFix

Clip



for OE number: 000 997 46 86  
191 867 199 01 C

Dia-meter mm	Pitch circle Ø mm	Height 1 / 2 mm	Version	Fitting Position	DU	Article no.
20	8	13 / 15	Mercedes-Benz VW	Wheel Side Boot Interior Trim	25	50267077

### ClipFix

Expanding Rivet



for OE number: 63 17 1 367 868  
000 988 16 25 Inner diameter: 3 mm

Pitch circle Ø mm	Width mm	Height mm	Depth mm	Version	DU	Article no.
7	10	15	10	BMW Mercedes-Benz	25	50267171

### ClipFix

Holding Bracket



for OE number: 6 089 805  
A 001 990 58 91 Port Thread: M8

Wall thickness mm	Width mm	Height mm	Depth mm	Version	DU	Article no.
0,8 to 4	27,5	10	18	Ford Mercedes-Benz	25	50267166

### ClipFix

Holding Bracket



for OE number: 638 984 08 61

Width mm	Height mm	Depth mm	Version	DU	Article no.
36	20	12	Mercedes-Benz	25	50267163

### ClipFix

Holding Bracket



for OE number: 201 698 06 60

Width mm	Height mm	Depth mm	Version	Fitting Position	DU	Article no.
58	15,5	13	Mercedes-Benz	Vehicle Roof	25	50267164

**ClipFix**

## Clip

for OE number: 000 991 28 95  
90 152 926

Diameter mm	Pitch circle Ø mm	Height 1 / 2 mm	Version	DU	Article no.
14	7 to 7,2	12 / 13,6	Mercedes-Benz Opel	25	<b>50267167</b>

MINI

**ClipFix**

## Clip



for OE number: 07 14 7 145 753 Info: with seal

Diameter mm	Pitch circle Ø mm	Height 1 / 2 mm	Version	Fitting Position	DU	Article no.
18	8	10 / 17	BMW Mini	Sidewall Interior Trim	25	<b>50267096</b>

**ClipFix**

## Expanding Rivet



for OE number: 51 48 1 938 725

Diameter mm	Pitch circle Ø mm	Height 1 / 2 mm	Version	Fitting Position	DU	Article no.
19	6,2	9 / 18	BMW Mini	Vehicle Door Dashboard	25	<b>50267116</b>

**ClipFix**

## Clip

for OE number: 51 32 1 938 884  
ALR1051 Info: with bracket

Width mm	Height mm	Depth mm	Version	Fitting Position	DU	Article no.
29	38	14	BMW Mini Land Rover	Window Fitting	25	<b>50267161</b>



# mitsubishi

## ClipFix

### Expanding Rivet



for OE number:

MR 328954  
91545SE0003  
01553-09321

Diameter mm	Pitch circle Ø mm	Height 1 / 2 mm	Version	Fitting Position	DU	Article no.
20	8	12 / 21	Mitsubishi Honda Nissan	Interior Trim Bumper Wheel Side Radiator Core	25	<b>50267098</b>

## ClipFix

### Clip



for OE number:

011 988 76 78  
2E1827649  
6 117 693  
M283083

Info:

with seal

Diameter mm	Pitch circle Ø mm	Height 1 / 2 mm	Version	Fitting Position	DU	Article no.
18	8,1 to 8,5	10 / 18	Mercedes-Benz VAG Ford Mitsubishi	Interior Trim	25	<b>50267141</b>





# NISSAN

## ClipFix

Expanding Rivet



for OE number: MR 328954  
91545SE0003  
01553-09321

Diameter mm	Pitch circle Ø mm	Height 1 / 2 mm	Version	Fitting Position	DU	Article no.
20	8	12 / 21	Mitsubishi Honda Nissan	Interior Trim Bumper Wheel Side Radiator Core	25	50267098

## ClipFix

Expanding Rivet



for OE number: 01553-09241

Diameter mm	Pitch circle Ø mm	Height 1 / 2 mm	Version	Fitting Position	DU	Article no.
18	9,6	17,5 / 27	Nissan	Interior Trim	25	50267136

## ClipFix

Rivet



for OE number: NA01-56-145 Bolt Head-/Nut Design: Cross Head  
63844-01A00

Diameter mm	Pitch circle Ø mm	Height 1 / 2 mm	Version	Fitting Position	DU	Article no.
20	7,5	18,5 / 27	Mazda Nissan	Wheel Side	25	50267108



# OPEL

## ClipFix

Expanding Rivet



for OE number: 17 19 245  
90138810  
51751429  
94530507

Diameter mm	Pitch circle Ø mm	Height 1 / 2 mm	Version	Fitting Position	DU	Article no.
16	8	11 / 21	Opel Saab Fiat Alfa Romeo Daewoo Chevrolet	Wheel Side Interior Trim	25	50267001

## ClipFix

Expanding Rivet



for OE number: 8E0 825 267  
1039463  
770 104 92 71  
4803228

Diameter mm	Pitch circle Ø mm	Height 1 / 2 mm	Version	Fitting Position	DU	Article no.
20	8,5	21 / 33	VAG Ford Renault Opel	Wheel Side Skid Plate Bumper Bonnet air scoop	25	50267003

## ClipFix

Expanding Rivet



for OE number: 199 016 92 92  
1 104 882  
51 47 8 170 166

Diameter mm	Pitch circle Ø mm	Height 1 / 2 mm	Version	Fitting Position	DU	Article no.
19	8	15 / 29	Mercedes-Benz Opel BMW	Wheel Side Vehicle Door	25	50267014

## ClipFix

Expanding Rivet



for OE number: 161 867 299 01C  
1 104 880  
6136889  
51 47 1 916 670

Diameter mm	Pitch circle Ø mm	Height 1 / 2 mm	Version	Fitting Position	DU	Article no.
16	8	11,5 / 24	VAG Opel Ford BMW	Vehicle Hatch Door Bumper Interior Trim	25	50267080



**ClipFix**  
Expanding Rivet



for OE number: 14 06 925 Diameter: 16 mm

Pitch circle Ø mm	Length mm	Height 1 / 2 mm	Version	Fitting Position	DU	Article no.
6	10,5	10,5 / 21	Opel	Interior Trim	 25	<b>50267095</b>

**ClipFix**  
Expanding Rivet



for OE number: 14 00 806

Diameter mm	Pitch circle Ø mm	Height 1 / 2 mm	Version	Fitting Position	DU	Article no.
20	6,5	20,5 / 41	Opel	Bumper	 25	<b>50267113</b>

**ClipFix**  
Expanding Rivet



for OE number: N 0385012  
90 058 826  
7703072172

Diameter mm	Pitch circle Ø mm	Height 1 / 2 mm	Version	DU	Article no.
10	5,9 to 7,1	12 / 25	VAG Opel Renault	 25	<b>50267146</b>

**ClipFix**  
Expanding Rivet



for OE number: 1 009 164  
000 990 55 92  
90 116 376  
N 10219501  
3923475  
500355891

Diameter mm	Pitch circle Ø mm	Height 1 / 2 mm	Version	DU	Article no.
16	5,5 to 6,4	11 / 18,5	Ford Mercedes-Benz Opel VAG Volvo Fiat Alfa Romeo Lancia Iveco	 25	<b>50267147</b>



1

## ClipFix

Expanding Rivet



for OE number: 90 414 659

Diameter mm	Pitch circle Ø mm	Height 1 / 2 mm	Version	DU	Article no.
15	6 to 6,2	20 / 42	Opel	25	50267162

## ClipFix

Expanding Rivet



for OE number: 000 990 22 92  
7903072116  
08968165  
7703072173  
947098

Diameter mm	Pitch circle Ø mm	Height 1 / 2 mm	Version	DU	Article no.
10	5 to 5,2	7,5 / 19	Mercedes-Benz Citroen Peugeot Opel Renault Volvo	25	50267170

## ClipFix

Expanding Rivet



for OE number: 000 990 37 92  
N10032301  
90356928

Diameter mm	Pitch circle Ø mm	Height 1 / 2 mm	Version	DU	Article no.
13	8 to 8,6	15 / 32	Mercedes-Benz VAG Opel	25	50267174

## ClipFix

Clip



for OE number: 811 807 577 C    Width: 11 mm  
811 807 577 F  
2240802

Height mm	Depth mm	Bore Ø mm	Version	Fitting Position	DU	Article no.
12	7	4,8	VAG Opel	at headlight Wing Boot Vehicle Door Dashboard Interior Trim Bonnet Bumper Wheel Side	25	50267043

## ClipFix

Expanding Rivet



for OE number: 90 482 706

Diameter mm	Pitch circle Ø mm	Height mm	Version	DU	Article no.
21	5	24,9	Opel	25	50267158

**ClipFix****Clip**

for OE number: 23 45 957

Diameter mm	Pitch circle Ø mm	Height 1 / 2 mm	Version	Fitting Position	DU	Article no.
17	8	13 / 18	Opel Daewoo	Vehicle Door Dashboard Interior Trim	25	<b>50267093</b>

**ClipFix****Clip**

for OE number: 23 45 959

Diameter mm	Pitch circle Ø mm	Height 1 / 2 mm	Version	Fitting Position	DU	Article no.
17	8 to 8,2	13 / 18	Opel	Vehicle Door Dashboard	25	<b>50267118</b>

**ClipFix****Clip**for OE number: 1H0 837 719      Pitch circle Ø: 5,5 mm  
90 579 619

Width mm	Height 1 / 2 mm	Depth mm	Version	Fitting Position	DU	Article no.
15	16,5 / 18,5	6	VAG Opel	Vehicle Door	25	<b>50267046</b>

**ClipFix****Holding Bracket**for OE number: N 10 154 322      Width: 25 mm  
207 217 563  
1470998

Height mm	Depth mm	Bore Ø mm	Version	Fitting Position	DU	Article no.
5	16	6,3	VAG Opel Ford	Wing Interior Trim Number Plate Light	25	<b>50267122</b>

**ClipFix****Holding Bracket**for OE number: 07 12 9 925 738  
211 837 223

Width mm	Height mm	Depth mm	Bore Ø mm	Version	DU	Article no.
24,5	4	11	4,2	BMW Opel VAG Ford	25	<b>50267073</b>

**ClipFix****Clip**

for OE number: 22 40 861

Diameter mm	Height mm	Version	Fitting Position	DU	Article no.
12	14,5	Opel	Interior Trim	25	<b>50267133</b>



## ClipFix

Expanding Rivet



for OE number: 90 230 960 Pitch circle Ø: 7,5 mm

Width mm	Height mm	Depth mm	Bore Ø mm	Version	DU	Article no.
11	12	11	5,8	Opel		25 50267152

## ClipFix

Blind Rivet



for OE number: 90 589 346

Diameter mm	Pitch circle Ø mm	Height 1 / 2 mm	Version	DU	Article no.
12	4,1	15 / 46	Opel		25 50267159

## ClipFix

Blind Rivet



for OE number: 11 086 102

Diameter mm	Pitch circle Ø mm	Height 1 / 2 mm	Version	DU	Article no.
9,5	4,9	16 / 46	Opel		25 50267181

## ClipFix

Clip



for OE number: 90040750

Diameter mm	Pitch circle Ø mm	Height 1 / 2 mm	Version	Fitting Position	DU	Article no.
28	7,5 to 7,8	14 / 18	Opel	Bonnet		25 50267190

## ClipFix

Clip



for OE number: 8964.57  
90431553

Diameter mm	Pitch circle Ø mm	Height 1 / 2 mm	Version	DU	Article no.
14	7,2 to 7,6	16 / 18	Peugeot Citroen Opel		25 50267192

**ClipFix**

Clip

for OE number: 000 991 28 95  
90 152 926

Diameter mm	Pitch circle Ø mm	Height 1 / 2 mm	Version	DU	Article no.
14	7 to 7,2	12 / 13,6	Mercedes-Benz Opel	25	<b>50267167</b>

**ClipFix**

Clip

for OE number: 23 46 824  
8964.81

Diameter mm	Pitch circle Ø mm	Height 1 / 2 mm	Version	Fitting Position	DU	Article no.
14	6,5	15,5 / 17,50	Opel Citroen Peugeot	Interior Trim	25	<b>50267008</b>

**ClipFix**

Clip

for OE number: 51 47 1 904 317  
000 988 03 28  
N 90201601H  
2 207 713  
6 998 849

Diameter mm	Pitch circle Ø mm	Height 1 / 2 mm	Version	Fitting Position	DU	Article no.
20	8	20 / 23	BMW Mercedes-Benz VAG Opel Ford	Vehicle Door Dashboard Interior Trim Boot	25	<b>50267036</b>

**ClipFix**

Holding Bracket



for OE number: 24417039 Wall thickness: 1,5 to 2 mm

Width mm	Height mm	Depth mm	Bore Ø mm	Version	DU	Article no.
16	14	12	5	Opel	25	<b>50267194</b>

**ClipFix**

Holding Bracket



for OE number: 90347304

Width mm	Height mm	Depth mm	Version	DU	Article no.
49	14	50	Opel	25	<b>50267195</b>



# PEUGEOT

## ClipFix

### Clip



for OE number: 7518.N8  
77 03 077 225

Diameter mm	Pitch circle Ø mm	Height 1 / 2 mm	Version	Fitting Position	DU	Article no.
35	8	22,5 / 25	Peugeot Citroen Renault	Wheel Side	25	50267006

## ClipFix

### Clip



for OE number: 6992.J4

Diameter mm	Pitch circle Ø mm	Height 1 / 2 mm	Version	Fitting Position	DU	Article no.
17	8 to 8,2	10 / 18	Peugeot	Dashboard Interior Trim	25	50267007

## ClipFix

### Clip



for OE number: 6992.93

Diameter mm	Height 1 / 2 mm	Version	Fitting Position	DU	Article no.
13	7 / 12	Peugeot	Vehicle Door Dashboard Interior Trim	25	50267088

## ClipFix

### Clip



for OE number: 6995.W1

Diameter mm	Pitch circle Ø mm	Height 1 / 2 mm	Version	Fitting Position	DU	Article no.
21	8	18 / 21	Peugeot Citroen	Interior Trim	25	50267186

## ClipFix

### Expanding Rivet



for OE number: 51 16 1 881 149  
N 10259301  
000 990 34 92  
6972.10  
7703072116

Diameter mm	Pitch circle Ø mm	Height 1 / 2 mm	Version	Fitting Position	DU	Article no.
10	5,5	11,5 / 23,5	BMW VAG Mercedes-Benz Peugeot Citroen Renault	Interior Trim Wheel Side	25	50267017





**ClipFix**  
Expanding Rivet



for OE number: 113 857 117 B  
6972.07

Diameter mm	Pitch circle Ø mm	Height 1 / 2 mm	Version	Fitting Position	DU	Article no.
8	3,5	8,2 / 14	VAG Peugeot Citroen	Interior Trim	25	<b>50267018</b>

**ClipFix**  
Expanding Rivet



for OE number: 6972.24  
001 990 24 92  
77 03 072 224

Diameter mm	Pitch circle Ø mm	Height 1 / 2 mm	Version	DU	Article no.
8	4 to 4,2	8,5 / 16,5	Peugeot Citroen Mercedes-Benz Renault	<b>NEW</b> 25	<b>50267183</b>

**ClipFix**  
Expanding Rivet



for OE number: 000 990 22 92  
7903072116  
08968165  
7703072173  
947098

Diameter mm	Pitch circle Ø mm	Height 1 / 2 mm	Version	DU	Article no.
10	5 to 5,2	7,5 / 19	Mercedes-Benz Citroen Peugeot Opel Renault Volvo	<b>NEW</b> 25	<b>50267170</b>

**ClipFix**  
Expanding Rivet



for OE number: 123 990 02 92  
7813.24

Diameter mm	Pitch circle Ø mm	Height 1 / 2 mm	Version	Fitting Position	DU	Article no.
20	8 to 8,2	10 / 20	Mercedes-Benz Citroen Peugeot	Radiator Core <b>NEW</b>	25	<b>50267082</b>

**ClipFix**  
Rivet



for OE number: 77 03 072 327 Bolt Head-/Nut Design: Torx  
963 338 87 80

Diameter mm	Pitch circle Ø mm	Height 1 / 2 mm	Version	DU	Article no.
9,8	6,2	9 / 21	Renault Peugeot Citroen	<b>NEW</b> 25	<b>50267188</b>



1

## ClipFix

Expanding Rivet



for OE number: 6991.X7  
999 507 497 40

Diameter mm	Pitch circle Ø mm	Height 1 / 2 mm	Version	Fitting Position	DU	Article no.
20	8	14 / 35	Peugeot Citroen Porsche	Wheel Side	25	50267131

## ClipFix

Expanding Rivet



for OE number: 8565.53

Diameter mm	Pitch circle Ø mm	Height 1 / 2 mm	Version	Fitting Position	DU	Article no.
20	8	13 / 20	Peugeot	Wheel Side Skid Plate Bumper	25	50267138

## ClipFix

Clip



for OE number: 6997.86 7701044547 9619769080  
Pitch circle Ø: 4 mm

Width mm	Height 1 / 2 mm	Depth mm	Version	Fitting Position	DU	Article no.
17	10 / 11,5	8	Peugeot Citroen Renault	Vehicle Door	25	50267086

## ClipFix

Screw



for OE number: 7030.16 Bolt Head-/Nut Design: Slot

Diameter mm	Pitch circle Ø mm	Height 1 / 2 mm	Version	DU	Article no.
11	6,5	19,5 / 24	Peugeot Citroen	25	50267106

## ClipFix

Holding Bracket



for OE number: 7030.18

Width mm	Height mm	Depth mm	Bore Ø mm	Version	DU	Article no.
23	10	12	6	Peugeot Citroen	25	50267107
<b>Accessories</b>				<b>see</b>	<b>DU</b>	
Screw ClipFix				Page 30	25	50267106

**ClipFix**

## Clip



for OE number: 8565.40  
7701049270  
007 173 79 18

Diameter mm	Pitch circle Ø mm	Height 1 / 2 mm	Version	Fitting Position	DU	Article no.
20	8,5	10 / 16	Peugeot Citroen Renault Fiat	Sidewall Skid Plate Bonnet	25	<b>50267129</b>

**ClipFix**

## Clip



for OE number: 6999.T4  
9605146380

Diameter mm	Pitch circle Ø mm	Height 1 / 2 mm	Version	Fitting Position	DU	Article no.
12	5	10 / 12	Peugeot Citroen Fiat	Vehicle Door Interior Trim	25	<b>50267130</b>

**ClipFix**

## Holding Bracket



for OE number: 6103426 Width: 25 mm  
7703046020

Height mm	Depth mm	Bore Ø mm	Version	Fitting Position	DU	Article no.
10	17	8	Renault Peugeot Ford	Vehicle Door	25	<b>50267135</b>

**ClipFix**

## Clip



for OE number: 8964.57  
90431553

Diameter mm	Pitch circle Ø mm	Height 1 / 2 mm	Version	DU	Article no.
14	7,2 to 7,6	16 / 18	Peugeot Citroen Opel	25	<b>50267192</b>

**ClipFix**

## Clip



for OE number: 6995.15  
7703077066

Diameter mm	Pitch circle Ø mm	Height 1 / 2 mm	Version	DU	Article no.
12,5	6,5	17,2 / 19	Peugeot Citroen Renault	25	<b>50267185</b>

**ClipFix**

## Clip



for OE number: 6992.95

Diameter mm	Pitch circle Ø mm	Height 1 / 2 mm	Version	DU	Article no.
18	6,5	16,5 / 18,3	Citroen Peugeot	25	<b>50267145</b>



1

## ClipFix

Clip



for OE number: 23 46 824  
8964.81

Diameter mm	Pitch circle Ø mm	Height 1 / 2 mm	Version	Fitting Position	DU	Article no.
14	6,5	15,5 / 17,50	Opel Citroen Peugeot	Interior Trim	25	50267008

## ClipFix

Clip



for OE number: 6966.33

Diameter mm	Pitch circle Ø mm	Height 1 / 2 mm	Version	Fitting Position	DU	Article no.
11,5	4,5	12 / 14,5	Peugeot	Vehicle Door 	25	50267083

## ClipFix

Clip



for OE number: 8964.77

Diameter mm	Pitch circle Ø mm	Height 1 / 2 mm	Version	Fitting Position	DU	Article no.
18,6	7	21 / 23,5	Peugeot	Interior Trim 	25	50267115

# PORSCHE

## ClipFix

Expanding Rivet



for OE number: 6991.X7  
999 507 497 40

Diameter mm	Pitch circle Ø mm	Height 1 / 2 mm	Version	Fitting Position	DU	Article no.
20	8	14 / 35	Peugeot Citroen Porsche	Wheel Side 	25	50267131



## RENAULT

## ClipFix

## Clip



for OE number: 77 03 077 435

Diameter mm	Pitch circle Ø mm	Height 1 / 2 mm	Version	Fitting Position	DU	Article no.
35,5	10,5	22,5 / 25,5	Renault Dacia	Wheel Side Bumper	25	<b>50267005</b>

## ClipFix

## Clip

for OE number: 7518.N8  
77 03 077 225

Diameter mm	Pitch circle Ø mm	Height 1 / 2 mm	Version	Fitting Position	DU	Article no.
35	8	22,5 / 25	Peugeot Citroen Renault	Wheel Side	25	<b>50267006</b>

## ClipFix

## Clip

for OE number: 6997.86  
7701044547  
9619769080 Pitch circle Ø: 4 mm

Width mm	Height 1 / 2 mm	Depth mm	Version	Fitting Position	DU	Article no.
17	10 / 11,5	8	Peugeot Citroen Renault	Vehicle Door 	25	<b>50267086</b>

## ClipFix

## Expanding Rivet

for OE number: 8E0 825 267  
1039463  
770 104 92 71  
4803228

Diameter mm	Pitch circle Ø mm	Height 1 / 2 mm	Version	Fitting Position	DU	Article no.
20	8,5	21 / 33	VAG Ford Renault Opel	Wheel Side Skid Plate Bumper Bonnet air scoop	25	<b>50267003</b>

## ClipFix

## Expanding Rivet

for OE number: 51 16 1 881 149  
N 10259301  
000 990 34 92  
6972.10  
7703072116

Diameter mm	Pitch circle Ø mm	Height 1 / 2 mm	Version	Fitting Position	DU	Article no.
10	5,5	11,5 / 23,5	BMW VAG Mercedes-Benz Peugeot Citroen Renault	Interior Trim Wheel Side	25	<b>50267017</b>



1

## ClipFix

Expanding Rivet



for OE number: N 0385012  
90 058 826  
7703072172

Diameter mm	Pitch circle Ø mm	Height 1 / 2 mm	Version	DU	Article no.
10	5,9 to 7,1	12 / 25	VAG Opel Renault	25	<b>50267146</b>

## ClipFix

Expanding Rivet



for OE number: 6972.24  
001 990 24 92  
77 03 072 224

Diameter mm	Pitch circle Ø mm	Height 1 / 2 mm	Version	DU	Article no.
8	4 to 4,2	8,5 / 16,5	Peugeot Citroen Mercedes-Benz Renault	25	<b>50267183</b>

## ClipFix

Expanding Rivet



for OE number: 000 990 22 92  
7903072116  
08968165  
7703072173  
947098

Diameter mm	Pitch circle Ø mm	Height 1 / 2 mm	Version	DU	Article no.
10	5 to 5,2	7,5 / 19	Mercedes-Benz Citroen Peugeot Opel Renault Volvo	25	<b>50267170</b>

## ClipFix

Expanding Rivet



for OE number: 77 03 072 502  
N90 229 301

Diameter mm	Pitch circle Ø mm	Height 1 / 2 mm	Version	Fitting Position	DU	Article no.
22	8	13 / 30	Renault VAG	Interior Trim	25	<b>50267114</b>

## ClipFix

Clip



for OE number: 8565.40  
7701049270  
007 173 79 18

Diameter mm	Pitch circle Ø mm	Height 1 / 2 mm	Version	Fitting Position	DU	Article no.
20	8,5	10 / 16	Peugeot Citroen Renault Fiat	Sidewall Skid Plate Bonnet	25	<b>50267129</b>



**ClipFix**  
Holding Bracket



for OE number: 6103426 Width: 25 mm  
7703046020

Height mm	Depth mm	Bore Ø mm	Version	Fitting Position	DU	Article no.
10	17	8	Renault Peugeot Ford	Vehicle Door	25	<b>50267135</b>

**ClipFix**  
Rivet



for OE number: 77 03 072 327 Bolt Head-/Nut Design: Torx  
963 338 87 80

Diameter mm	Pitch circle Ø mm	Height 1 / 2 mm	Version	DU	Article no.
9,8	6,2	9 / 21	Renault Peugeot Citroen	25	<b>50267188</b>

**ClipFix**  
Clip



for OE number: 6995.15  
7703077066

Diameter mm	Pitch circle Ø mm	Height 1 / 2 mm	Version	DU	Article no.
12,5	6,5	17,2 / 19	Peugeot Citroen Renault	25	<b>50267185</b>



# SAAB

## ClipFix

### Expanding Rivet

for OE number:

17 19 245  
90138810  
51751429  
94530507



Diameter mm	Pitch circle Ø mm	Height 1 / 2 mm	Version	Fitting Position	DU	Article no.
16	8	11 / 21	Opel Saab Fiat Alfa Romeo Daewoo Chevrolet	Wheel Side Interior Trim	25	50267001

# SUBARU

## ClipFix

### Rivet

for OE number:

71 741 883  
9046707164  
09409-07332



Diameter mm	Pitch circle Ø mm	Height 1 / 2 mm	Version	Fitting Position	DU	Article no.
20	7	10 / 21	Fiat Toyota Lexus Subaru Suzuki	Wheel Side 	25	50267117

# SUZUKI

## ClipFix

### Rivet

for OE number:

71 741 883  
9046707164  
09409-07332



Diameter mm	Pitch circle Ø mm	Height 1 / 2 mm	Version	Fitting Position	DU	Article no.
20	7	10 / 21	Fiat Toyota Lexus Subaru Suzuki	Wheel Side 	25	50267117





## TOYOTA

## ClipFix

## Rivet



for OE number: 90467-07166

Diameter mm	Pitch circle Ø mm	Height 1 / 2 mm	Version	Fitting Position	DU	Article no.
20	7	8,5 / 18,5	Toyota	Wheel Side		25 <b>50267101</b>

## ClipFix

## Rivet



for OE number: 90467-10183

Diameter mm	Pitch circle Ø mm	Height 1 / 2 mm	Version	Fitting Position	DU	Article no.
18	7	7,5 / 17	Lexus Toyota	Wheel Side		25 <b>50267111</b>

## ClipFix

## Rivet

for OE number: 71 741 883  
9046707164  
09409-07332

Diameter mm	Pitch circle Ø mm	Height 1 / 2 mm	Version	Fitting Position	DU	Article no.
20	7	10 / 21	Fiat Toyota Lexus Subaru Suzuki	Wheel Side		25 <b>50267117</b>

## ClipFix

## Clip



for OE number: 90189-06013 Diameter: 20 mm

Pitch circle Ø mm	Height 1 / 2 mm	Bore Ø mm	Version	Fitting Position	DU	Article no.
8	18 / 19	5,5	Toyota Lexus	Interior Trim		25 <b>50267104</b>

## ClipFix

## Clip



for OE number: 90467-10161

Diameter mm	Pitch circle Ø mm	Height 1 / 2 mm	Version	Fitting Position	DU	Article no.
19	8	13 / 20	Toyota Lexus	Interior Trim		25 <b>50267127</b>



## ClipFix

### Clip



for OE number: 357 827 998 Diameter: 16 mm

Pitch circle Ø mm	Height 1 / 2 mm	Bore Ø mm	Version	Fitting Position	DU	Article no.
8	19,5 / 21	4,8	VAG	Vehicle Door	25	50267054

## ClipFix

### Clip



for OE number: N90 821 401 Diameter: 15 mm

Pitch circle Ø mm	Height 1 / 2 mm	Bore Ø mm	Version	Fitting Position	DU	Article no.
7,5	19,5 / 21,5	4,8	VAG	Bumper Vehicle Windscreen Vehicle Roof Wheel Side Bonnet Wing Sidewall Interior Trim	25	50267058

## ClipFix

### Clip



for OE number: N90 833 801

Diameter mm	Height 1 / 2 mm	Bore Ø mm	Version	Fitting Position	DU	Article no.
15	12 / 13,5	4,2	VAG	Wing Bumper Wheel Side Vehicle Door Boot Bonnet	25	50267053

## ClipFix

### Expanding Rivet



for OE number: 51 11 1 908 077  
N90 359 101  
A 000 990 54 92

Diameter mm	Pitch circle Ø mm	Height 1 / 2 mm	Version	Fitting Position	DU	Article no.
15	6,5	15,5 / 31,5	BMW VW Mercedes-Benz	Interior Trim Radiator Core Bonnet air scoop Bumper	25	50267041

## ClipFix

### Expanding Rivet



for OE number: 8E0 825 267  
1039463  
770 104 92 71  
4803228

Diameter mm	Pitch circle Ø mm	Height 1 / 2 mm	Version	Fitting Position	DU	Article no.
20	8,5	21 / 33	VAG Ford Renault Opel	Wheel Side Skid Plate Bumper Bonnet air scoop	25	50267003



**ClipFix**  
Expanding Rivet



for OE number: 171 885 767  
001 994 41 45

Diameter mm	Pitch circle Ø mm	Height 1 / 2 mm	Version	Fitting Position	DU	Article no.
18	7,5	17 / 27	VAG Mercedes-Benz	Vehicle Hatch Door Interior Trim	25	<b>50267015</b>

**ClipFix**  
Expanding Rivet



for OE number: 77 03 072 502  
N90 229 301

Diameter mm	Pitch circle Ø mm	Height 1 / 2 mm	Version	Fitting Position	DU	Article no.
22	8	13 / 30	Renault VAG	Interior Trim 	25	<b>50267114</b>

**ClipFix**  
Expanding Rivet



for OE number: 51 16 1 881 149  
N 10259301  
000 990 34 92  
6972.10  
7703072116

Diameter mm	Pitch circle Ø mm	Height 1 / 2 mm	Version	Fitting Position	DU	Article no.
10	5,5	11,5 / 23,5	BMW VAG Mercedes-Benz Peugeot Citroen Renault	Interior Trim Wheel Side	25	<b>50267017</b>

**ClipFix**  
Expanding Rivet



for OE number: 113 857 117 B  
6972.07

Diameter mm	Pitch circle Ø mm	Height 1 / 2 mm	Version	Fitting Position	DU	Article no.
8	3,5	8,2 / 14	VAG Peugeot Citroen	Interior Trim	25	<b>50267018</b>

**ClipFix**  
Expanding Rivet



for OE number: N 107 009 01

Diameter mm	Pitch circle Ø mm	Height 1 / 2 mm	Version	Fitting Position	DU	Article no.
15	4,5	11,5 / 25	VAG	Bumper 	25	<b>50267119</b>



## ClipFix

### Expanding Rivet



for OE number: 1U0 863 142

Diameter mm	Pitch circle Ø mm	Height 1 / 2 mm	Version	DU	Article no.
14	8	11 / 24	VAG	25	50267144

## ClipFix

### Expanding Rivet



for OE number: N 0385012  
90 058 826  
7703072172

Diameter mm	Pitch circle Ø mm	Height 1 / 2 mm	Version	DU	Article no.
10	5,9 to 7,1	12 / 25	VAG Opel Renault	25	50267146

## ClipFix

### Expanding Rivet



for OE number: 1 009 164  
000 990 55 92  
90 116 376  
N 10219501  
3923475  
500355891

Diameter mm	Pitch circle Ø mm	Height 1 / 2 mm	Version	DU	Article no.
16	5,5 to 6,4	11 / 18,5	Ford Mercedes-Benz Opel VAG Volvo Fiat Alfa Romeo Lancia Iveco	25	50267147

## ClipFix

### Expanding Rivet



for OE number: 000 990 37 92  
N10032301  
90356928

Diameter mm	Pitch circle Ø mm	Height 1 / 2 mm	Version	DU	Article no.
13	8 to 8,6	15 / 32	Mercedes-Benz VAG Opel	25	50267174



**ClipFix**  
Expanding Rivet



for OE number: N 105 835 01 9B9  
51 49 8 166 702

Diameter mm	Pitch circle Ø mm	Height 1 / 2 mm	Version	DU	Article no.
17	7,8 to 8,8	12,3 / 27,5	VAG BMW	 25	50267191

**ClipFix**  
Clip



for OE number: 3B0 837 732

Diameter mm	Height 1 / 2 mm	Version	Fitting Position	DU	Article no.
13,5	8 / 13	VAG	Vehicle Door	25	50267027

**ClipFix**  
Clip



for OE number: 823 863 203 01C  
1489595

Diameter mm	Pitch circle Ø mm	Height 1 / 2 mm	Version	Fitting Position	DU	Article no.
14	6	14,5 / 17	VAG Ford	Interior Trim Vehicle Door Vehicle Hatch Door Boot Bonnet Radiator Core	25	50267028

**ClipFix**  
Clip



for OE number: 51 47 1 904 317  
000 988 03 28  
N 90201601H  
2 207 713  
6 998 849

Diameter mm	Pitch circle Ø mm	Height 1 / 2 mm	Version	Fitting Position	DU	Article no.
20	8	20 / 23	BMW Mercedes-Benz VAG Opel Ford	Vehicle Door Dashboard Interior Trim Boot	25	50267036

**ClipFix**  
Clip



for OE number: 000 997 46 86  
191 867 199 01 C

Diameter mm	Pitch circle Ø mm	Height 1 / 2 mm	Version	Fitting Position	DU	Article no.
20	8	13 / 15	Mercedes-Benz VW	Wheel Side Boot Interior Trim	 25	50267077



## ClipFix

### Clip

for OE number: 811 807 577 C Width: 11 mm  
811 807 577 F  
2240802



Height mm	Depth mm	Bore Ø mm	Version	Fitting Position	DU	Article no.
12	7	4,8	VAG Opel	at headlight Wing Boot Vehicle Door Dashboard Interior Trim Bonnet Bumper Wheel Side	25	<b>50267043</b>

## ClipFix

### Clip

for OE number: 867 809 966



Diameter mm	Height 1 / 2 mm	Bore Ø mm	Version	Fitting Position	DU	Article no.
12	13 / 14,5	4,2	VAG	Wheel Side	25	<b>50267066</b>

## ClipFix

### Holding Bracket

for OE number: 8D0 805 960 Width: 25 mm



Height mm	Depth mm	Bore Ø mm	Version	Fitting Position	DU	Article no.
10	24,5	7,5	VAG	Bumper	25	<b>50267044</b>
<b>Accessories</b>					<b>see</b>	<b>DU</b>
Screw ClipFix					Page 79	25 <b>50267057</b>
					Page 82	25 <b>50267067</b>

## ClipFix

### Clip

for OE number: 1H0 837 719 Pitch circle Ø: 5,5 mm  
90 579 619



Width mm	Height 1 / 2 mm	Depth mm	Version	Fitting Position	DU	Article no.
15	16,5 / 18,5	6	VAG Opel	Vehicle Door	25	<b>50267046</b>

## ClipFix

### Clip

for OE number: 4A0 805 121 C



Diameter mm	Pitch circle Ø mm	Height mm	Version	Fitting Position	DU	Article no.
25	10	28	VAG	Wheel Side	25	<b>50267047</b>

**ClipFix**

Clip



for OE number: 4A0 805 121 A Bolt Head-/Nut Design: Slot

Diameter mm	Pitch circle Ø mm	Height 1 / 2 mm	Version	Fitting Position	DU	Article no.
25	10	22 / 28	VAG	Bumper Wheel Side	25	50267062

for article number

50267059

**ClipFix**

Screw



for OE number: 8D0 805 121 B Bolt Head-/Nut Design: Slot

Diameter mm	Height mm	Version	Fitting Position	DU	Article no.
18	23,5	VAG	Bumper	25	50267057

for article number

50267044

**ClipFix**

Clip



for OE number: 3B0 868 243

Diameter mm	Pitch circle Ø mm	Height 1 / 2 mm	Version	Fitting Position	DU	Article no.
22	9,5	9,5 / 21	VAG	Vehicle Door Vehicle Hatch Door Dashboard	25	50267048

**ClipFix**

Clip



for OE number: 8E0 868 243

Diameter mm	Pitch circle Ø mm	Height 1 / 2 mm	Version	Fitting Position	DU	Article no.
27	10	16 / 30	VAG	Vehicle Door Dashboard	25	50267060

**ClipFix**

Clip



for OE number: 7L6 868 243

Diameter mm	Pitch circle Ø mm	Height 1 / 2 mm	Version	Fitting Position	DU	Article no.
23	8	9 / 31	VAG	Vehicle Door Dashboard Interior Trim	25	50267103

**ClipFix**

Clip



for OE number: 6Q0 868 243

Diameter mm	Pitch circle Ø mm	Height 1 / 2 mm	Version	Fitting Position	DU	Article no.
23	8	9 / 28	VAG	Vehicle Door Dashboard	25	50267052



## ClipFix

### Clip



for OE number: 801 867 299 01C

Diameter mm	Pitch circle Ø mm	Height 1 / 2 mm	Version	Fitting Position	DU	Article no.
14	8	18 / 20	VAG	Vehicle Hatch Door Radiator Core Interior Trim	25	<b>50267049</b>

## ClipFix

### Clip



for OE number: 7M0 867 299 K  
1008068

Diameter mm	Pitch circle Ø mm	Height 1 / 2 mm	Version	Fitting Position	DU	Article no.
18	8	14 / 21	VAG Ford	Vehicle Door Dashboard	25	<b>50267050</b>

## ClipFix

### Clip



for OE number: 011 988 76 78 Info: with seal  
2E1827649  
6 117 693  
M283083

Diameter mm	Pitch circle Ø mm	Height 1 / 2 mm	Version	Fitting Position	DU	Article no.
18	8,1 to 8,5	10 / 18	Mercedes-Benz VAG Ford Mitsubishi	Interior Trim	25	<b>50267141</b>

## ClipFix

### Clip



for OE number: 4D0 867 299 A  
A 005 988 82 78

Diameter mm	Pitch circle Ø mm	Height 1 / 2 mm	Version	Fitting Position	DU	Article no.
18	7,9 to 8	10 / 16,5	VAG Mercedes-Benz	Interior Trim	25	<b>50267142</b>

## ClipFix

### Clip



for OE number: 171 867 299 B

Diameter mm	Pitch circle Ø mm	Height 1 / 2 mm	Version	Fitting Position	DU	Article no.
18	7,9	14 / 21	VAG	Interior Trim	25	<b>50267143</b>



**ClipFix****Clip**

for OE number: 823 867 299

Diameter mm	Pitch circle Ø mm	Height 1 / 2 mm	Version	Fitting Position	DU	Article no.
18	8	13,5 / 21	VAG	Dashboard Vehicle Door Vehicle Hatch Door Interior Trim	25	<b>50267061</b>

**ClipFix****Clip**for OE number: N90 205 501 Pitch circle Ø: 6,5 to 6,7 mm  
Mounting Diameter: 35 mm

Wall thickness mm	Length mm	Width mm	Version	Fitting Position	DU	Article no.
0,7 to 1,5	140	4,5	VAG	Engine Bay Bonnet	25	<b>50267055</b>

**ClipFix****Clip**

for OE number: 251 823 717 Pitch circle Ø: 4 mm

Width mm	Height 1 / 2 mm	Depth mm	Version	Fitting Position	DU	Article no.
13	10 / 11,5	5	VAG	Bonnet Vehicle Door	25	<b>50267056</b>

**ClipFix****Clip**

for OE number: 4A0 805 163 Width: 20 mm

Height mm	Depth mm	Bore Ø mm	Version	Fitting Position	DU	Article no.
15,5	14,5	6,5	VAG	Bumper Wheel Side	25	<b>50267059</b>
<b>Accessories</b>					<b>see</b>	<b>DU</b>
Clip ClipFix					Page 79	<b>50267062</b>

**ClipFix****Grommet**

for OE number: 1H0 853 586

Diameter mm	Inner diameter mm	Height mm	Version	Fitting Position	DU	Article no.
13	6	12	VAG Lancia Fiat	Boot Sidewall	25	<b>50267063</b>



## ClipFix

### Blind Rivet



for OE number: N90 634 901

Diameter mm	Pitch circle Ø mm	Height 1 / 2 mm	Version	Fitting Position	DU	Article no.
12	4	14 / 46	VAG	Wheel Side	25	50267064

## ClipFix

### Screw



for OE number: N90 775 001 Bolt Head-/Nut Design: Hexagon

Diameter mm	Pitch circle Ø mm	Height 1 / 2 mm	Version	Fitting Position	DU	Article no.
14	4,8	16 / 19,5	VAG	Vehicle Door Vehicle Hatch Door Wing Boot Bonnet Interior Trim Bumper Wheel Side Bonnet air scoop at headlight	25	50267065

## ClipFix

### Screw



for OE number: 8D0 805 121 Bolt Head-/Nut Design: Slot

Diameter mm	Pitch circle Ø mm	Height mm	Version	Fitting Position	DU	Article no.
18	7	22	VAG	Bumper Wheel Side	25	50267067

for article number 50267044 

## ClipFix

### Expanding Rivet



for OE number: 123 990 00 92  
333 867 633 4FB

Diameter mm	Pitch circle Ø mm	Height 1 / 2 mm	Version	Fitting Position	DU	Article no.
14	8	11 / 23	Mercedes-Benz VAG	Vehicle Hatch Door Boot Bonnet	 25	50267078

## ClipFix

### Grommet



for OE number: 113 857 219 A

Diameter mm	Inner diameter mm	Height mm	Version	DU	Article no.
16	7	16,5	VAG	 25	50267079



**ClipFix**  
Expanding Rivet



for OE number: 161 867 299 01C  
1 104 880  
6136889  
51 47 1 916 670

Diameter mm	Pitch circle Ø mm	Height 1 / 2 mm	Version	Fitting Position	DU	Article no.
16	8	11,5 / 24	VAG Opel Ford BMW	Vehicle Hatch Door Bumper Interior Trim	25	50267080

**ClipFix**  
Expanding Rivet



for OE number: N 0385501  
7 200 671

Diameter mm	Pitch circle Ø mm	Height 1 / 2 mm	Version	Fitting Position	DU	Article no.
12,5	8,5	11 / 17	VAG Ford	Bumper Wheel Side Bonnet Sidewall Wing Interior Trim Radiator Core	25	50267085

**ClipFix**  
Holding Bracket



for OE number: 1H0 853 585

Width mm	Height mm	Depth mm	Version	Fitting Position	DU	Article no.
38	23	34	VAG	Sidewall	25	50267090

**ClipFix**  
Holding Bracket



for OE number: 7L0 853 547 A

Width mm	Height mm	Depth mm	Version	DU	Article no.
30	15	9	VAG	25	50267187

**ClipFix**  
Holding Bracket



for OE number: 155 853 585

Width mm	Height mm	Depth mm	Version	Fitting Position	DU	Article no.
18	16	7	VAG	Sidewall	25	50267051

**ClipFix**  
Holding Bracket



for OE number: 113 853 585 C

Width mm	Height mm	Depth mm	Version	Fitting Position	DU	Article no.
18	12	6	VAG	Sidewall	25	50267068



1

### ClipFix

Holding Bracket



for OE number: 191 853 733 A

Width mm	Height mm	Depth mm	Version	Fitting Position	DU	Article no.
31	5	8	VAG	Vehicle Roof	25	50267094

### ClipFix

Holding Bracket



for OE number: 1H0 853 733 B

Width mm	Height mm	Depth mm	Version	Fitting Position	DU	Article no.
32	6	10,5	VAG	Vehicle Roof	25	50267045

### ClipFix

Clip



for OE number: N 105 168 01 Diameter: 15 mm

Pitch circle Ø mm	Height 1 / 2 mm	Bore Ø mm	Version	Fitting Position	DU	Article no.
8	14,5 / 17,5	4,8	VAG	Vehicle Door Vehicle Hatch Door Dashboard Bonnet Interior Trim Bumper Vehicle Roof Sidewall Transmission End Boot	25	50267091

### ClipFix

Clip



for OE number: 1H0 867 199 01C

Diameter mm	Pitch circle Ø mm	Height 1 / 2 mm	Version	Fitting Position	DU	Article no.
23	8,5	16 / 18,5	VAG	Sidewall Interior Trim	25	50267100

### ClipFix

Holding Bracket



for OE number: N 10 154 322 Width: 25 mm  
207 217 563  
1470998

Height mm	Depth mm	Bore Ø mm	Version	Fitting Position	DU	Article no.
5	16	6,3	VAG Opel Ford	Wing Interior Trim Number Plate Light	25	50267122

### ClipFix

Holding Bracket



for OE number: 07 12 9 925 738  
211 837 223

Width mm	Height mm	Depth mm	Bore Ø mm	Version	DU	Article no.
24,5	4	11	4,2	BMW Opel VAG Ford	25	50267073



**ClipFix**  
Holding Bracket



for OE number: N90 335 004  
6 715 468

Diameter mm	Version	Fitting Position	DU	Article no.
30	VAG Ford	Vehicle Door Interior Trim Bonnet Bumper Skid Plate	25	<b>50267069</b>

**ClipFix**  
Holding Bracket



for OE number: N90 335 005

Diameter mm	Version	DU	Article no.
30	VAG	25	<b>50267140</b>

**ClipFix**  
Screw



for OE number: N90 974 701 Bolt Head-/Nut Design: Torx

Diameter mm	Pitch circle Ø mm	Height 1 / 2 mm	Version	DU	Article no.
20	5	16 / 19	VAG	 25	<b>50267149</b>

**ClipFix**  
Holding Bracket



for OE number: 51 41 6 654 189  
N 0143893  
0 537 655  
3 104 426

Width mm	Height mm	Depth mm	Bore Ø mm	Version	DU	Article no.
15,75	15,65	9,3	8	BMW VAG Ford Volvo	 25	<b>50267168</b>



## ClipFix

### Clip



for OE number: 1 268 176

Diameter mm	Pitch circle Ø mm	Height 1 / 2 mm	Version	DU	Article no.
16	6	14 / 38,5	Volvo	25	<b>50267084</b>

## ClipFix

### Expanding Rivet



for OE number: 000 990 22 92  
7903072116  
08968165  
7703072173  
947098

Diameter mm	Pitch circle Ø mm	Height 1 / 2 mm	Version	DU	Article no.
10	5 to 5,2	7,5 / 19	Mercedes-Benz Citroen Peugeot Opel Renault Volvo	25	<b>50267170</b>

## ClipFix

### Expanding Rivet



for OE number: 1 009 164  
000 990 55 92  
90 116 376  
N 10219501  
3923475  
500355891

Diameter mm	Pitch circle Ø mm	Height 1 / 2 mm	Version	DU	Article no.
16	5,5 to 6,4	11 / 18,5	Ford Mercedes-Benz Opel VAG Volvo Fiat Alfa Romeo Lancia Iveco	25	<b>50267147</b>

## ClipFix

### Holding Bracket



for OE number: 51 41 6 654 189  
N 0143893  
0 537 655  
3 104 426

Width mm	Height mm	Depth mm	Bore Ø mm	Version	DU	Article no.
15,75	15,65	9,3	8	BMW VAG Ford Volvo	25	<b>50267168</b>



**Blind Rivet** **50267089**  
Page 16, 33, 39

**Blind Rivet** **50267039**  
Page 25

**Blind Rivet** **50267179**  
Page 25

**Blind Rivet** **50267180**  
Page 25

**Blind Rivet** **50267134**  
Page 39

**Blind Rivet** **50267159**  
Page 62

**Blind Rivet** **50267181**  
Page 62

**Blind Rivet** **50267064**  
Page 82

**Clip** **50267148**  
Page 15, 32, 43, 44



Clip 50267081  
Page 15, 32, 43, 44



Clip 50267012  
Page 15, 32, 43, 44



Clip 50267011  
Page 15, 32, 44



Clip 50267087  
Page 15, 33, 45



Clip 50267150  
Page 16, 34, 36, 43, 45



Clip 50267009  
Page 17



Clip 50267010  
Page 17



Clip 50267096  
Page 17, 55



Clip 50267126  
Page 17



Clip 50267034  
Page 18



Clip 50267037  
Page 18



Clip 50267072  
Page 18



Clip 50267036  
Page 18, 35, 49, 63, 77



Clip 50267020  
Page 21, 53



Clip 50267023  
Page 22, 53



Clip 50267030  
Page 22



Clip 50267161  
Page 23, 55



Clip 50267189  
Page 24





Clip 50267006  
Page 27, 64, 69



Clip 50267008  
Page 27, 63, 68



Clip 50267013  
Page 27



Clip 50267129  
Page 27, 34, 67, 70



Clip 50267121  
Page 27



Clip 50267186  
Page 28, 64



Clip 50267086  
Page 28, 66, 69



Clip 50267130  
Page 29, 34, 67



Clip 50267192  
Page 30, 62, 67



Clip 50267185  
Page 30, 67, 71



Clip 50267145  
Page 30, 67



Clip 50267005  
Page 31, 69



Clip 50267093  
Page 31, 61



Clip 50267028  
Page 35, 77



Clip 50267132  
Page 35



Clip 50267050  
Page 35, 80



Clip 50267141  
Page 35, 48, 56, 80



Clip 50267099  
Page 37



Clip 50267124  
Page 39



Clip 50267154  
Page 39



Clip 50267151  
Page 40



Clip 50267156  
Page 40



Clip 50267176  
Page 41



Clip 50267178  
Page 41



Clip 50267104  
Page 46, 73



Clip 50267127  
Page 46, 73



Clip 50267025  
Page 48



Clip

50267142

Page 48, 80



Clip

50267071

Page 48



Clip

50267077

Page 54, 77



Clip

50267167

Page 55, 63



Clip

50267043

Page 60, 78



Clip

50267118

Page 61



Clip

50267046

Page 61, 78



Clip

50267133

Page 61



Clip

50267190

Page 62



Clip 50267007  
Page 64



Clip 50267088  
Page 64



Clip 50267083  
Page 68



Clip 50267115  
Page 68



Clip 50267054  
Page 74



Clip 50267058  
Page 74



Clip 50267053  
Page 74



Clip 50267027  
Page 77



Clip 50267066  
Page 78



Clip

50267047

Page 78



Clip

50267062

Page 79



Clip

50267048

Page 79



Clip

50267060

Page 79



Clip

50267103

Page 79



Clip

50267052

Page 79



Clip

50267049

Page 80



Clip

50267143

Page 80



Clip

50267061

Page 81



Clip

50267055

Page 81



Clip

50267056

Page 81



Clip

50267059

Page 81



Clip

50267091

Page 84



Clip

50267100

Page 84



Clip

50267084

Page 86



Expanding Rivet

50267001

Page 16, 26, 31, 32, 58, 72



Expanding Rivet

50267147

Page 16, 33, 37, 43, 45, 50, 59, 76, 86



Expanding Rivet

50267080

Page 18, 36, 58, 83





Expanding Rivet

50267014

Page 19, 50, 58



Expanding Rivet

50267016

Page 19



Expanding Rivet

50267017

Page 19, 28, 50, 64, 69, 75



Expanding Rivet

50267033

Page 19



Expanding Rivet

50267191

Page 20, 77



Expanding Rivet

50267038

Page 20, 51



Expanding Rivet

50267116

Page 21, 55



Expanding Rivet

50267040

Page 21



Expanding Rivet

50267041

Page 21, 52, 74



Expanding Rivet

50267042

Page 21



Expanding Rivet

50267171

Page 23, 54



Expanding Rivet

50267018

Page 28, 65, 75



Expanding Rivet

50267082

Page 28, 52, 65



Expanding Rivet

50267131

Page 29, 66, 68



Expanding Rivet

50267170

Page 29, 51, 60, 65, 70, 86



Expanding Rivet

50267183

Page 29, 51, 65, 70



Expanding Rivet

50267002

Page 36



Expanding Rivet

50267003

Page 36, 58, 69, 74



**Expanding Rivet** **50267085**  
Page 36, 83



**Expanding Rivet** **50267112**  
Page 37



**Expanding Rivet** **50267155**  
Page 40



**Expanding Rivet** **50267153**  
Page 40



**Expanding Rivet** **50267098**  
Page 42, 56, 57



**Expanding Rivet** **50267015**  
Page 50, 75



**Expanding Rivet** **50267174**  
Page 51, 60, 76



**Expanding Rivet** **50267078**  
Page 52, 82



**Expanding Rivet** **50267199**  
Page 52



Expanding Rivet **50267196**  
Page 52



Expanding Rivet **50267136**  
Page 57



Expanding Rivet **50267095**  
Page 59



Expanding Rivet **50267113**  
Page 59



Expanding Rivet **50267146**  
Page 59, 70, 76



Expanding Rivet **50267162**  
Page 60



Expanding Rivet **50267158**  
Page 60



Expanding Rivet **50267152**  
Page 62



Expanding Rivet **50267138**  
Page 66



Expanding Rivet

50267114

Page 70, 75



Expanding Rivet

50267119

Page 75



Expanding Rivet

50267144

Page 76



Grommet

50267172

Page 24



Grommet

50267128

Page 24



Grommet

50267063

Page 33, 44, 81



Grommet

50267026

Page 49



Grommet

50267022

Page 49



Grommet

50267177

Page 49



**Grommet** **50267076**  
Page 49



**Grommet** **50267079**  
Page 82



**Holding Bracket** **50267031**  
Page 17



**Holding Bracket** **50267004**  
Page 22



**Holding Bracket** **50267029**  
Page 22



**Holding Bracket** **50267175**  
Page 22



**Holding Bracket** **50267032**  
Page 22



**Holding Bracket** **50267109**  
Page 23



**Holding Bracket** **50267073**  
Page 23, 38, 61, 84



Holding Bracket

50267092

Page 23, 37



Holding Bracket

50267097

Page 23



Holding Bracket

50267193

Page 24

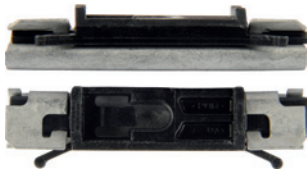

Holding Bracket

50267102

Page 24



Holding Bracket

50267168

Page 24, 40, 85, 86



Holding Bracket

50267107

Page 30, 66

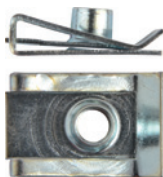

Holding Bracket

50267105

Page 33, 38



Holding Bracket

50267122

Page 37, 61, 84



Holding Bracket

50267123

Page 38



**Holding Bracket** 50267135  
Page 38, 67, 71



**Holding Bracket** 50267166  
Page 38, 54



**Holding Bracket** 50267069  
Page 38, 85



**Holding Bracket** 50267125  
Page 39



**Holding Bracket** 50267024  
Page 48



**Holding Bracket** 50267019  
Page 51



**Holding Bracket** 50267021  
Page 53



**Holding Bracket** 50267070  
Page 54



**Holding Bracket** 50267163  
Page 54





**Holding Bracket** **50267164**  
Page 54

**Holding Bracket** **50267194**  
Page 63

**Holding Bracket** **50267195**  
Page 63

**Holding Bracket** **50267044**  
Page 78

**Holding Bracket** **50267090**  
Page 83

**Holding Bracket** **50267187**  
Page 83

**Holding Bracket** **50267051**  
Page 83

**Holding Bracket** **50267068**  
Page 83

**Holding Bracket** **50267094**  
Page 84



Holding Bracket

50267045

Page 84



Holding Bracket

50267140

Page 85



Rivet

50267035

Page 20



Rivet

50267184

Page 20, 40



Rivet

50267120

Page 20



Rivet

50267188

Page 29, 65, 71



Rivet

50267117

Page 34, 46, 72, 73



Rivet

50267182

Page 41



Rivet

50267110

Page 42



Rivet

50267111

Page 46, 73



Rivet

50267108

Page 47, 57



Rivet

50267137

Page 47



Rivet

50267169

Page 53



Rivet

50267173

Page 53



Rivet

50267101

Page 73



Screw

50267106

Page 30, 66



Screw

50267157

Page 53



Screw

50267057

Page 79



Screw

50267065

Page 82



Screw

50267067

Page 82



Screw

50267149

Page 85



# Assortment, fasteners



## ClipFix Assortment, fasteners



Version	Quantity	DU	Article no.
VAG Mercedes-Benz 	185	1	54267001
<b>Content</b>		<b>QU</b>	
Assortment Box		1	99994507
Blind Rivet		10	50267064
ClipFix		10	50267047
Clip		10	50267050
ClipFix		10	50267059
		10	50267060
		10	50267062
		10	50267066
Expanding Rivet		20	50267014
ClipFix		10	50267038
Grommet		10	50267026
ClipFix			
Holding Bracket		10	50267044
ClipFix		10	50267069
		25	50267140
Screw		10	50267057
ClipFix		10	50267065
		10	50267067



## ClipFix

Assortment, fasteners



Version	Quantity	DU	Article no.
VAG BMW Opel Peugeot Mercedes-Benz	240	1	54267002
Content		QU	
Assortment Box		1	99994507
Clip		10	50267007
ClipFix		10	50267037
		10	50267048
		10	50267081
		10	50267083
		10	50267084
		10	50267086
		10	50267087
		10	50267088
		10	50267143
		10	50267145
		10	50267148
Expanding Rivet		10	50267001
ClipFix		20	50267017
		10	50267038
		10	50267041
		10	50267042
		10	50267080
		10	50267082
		10	50267085
		10	50267144
		10	50267146
		10	50267147

## ClipFix

Assortment, fasteners



Version	Quantity	DU	Article no.
VAG	180	1	54267003
Content		QU	
Assortment Box		1	99994507
Clip		10	50267048
ClipFix		10	50267050
		10	50267052
		10	50267059
		10	50267060
		10	50267062
		10	50267091
		10	50267103
		10	50267141
		10	50267142
Holding Bracket		10	50267069
ClipFix		10	50267090
		10	50267094
		10	50267140
Screw		10	50267057
ClipFix		10	50267065
		10	50267067
		10	50267149



## ClipFix

Assortment, fasteners



Version	Quantity	DU	Article no.
BMW 	185	1	54267004
Content		QU	
Assortment Box		1	99994509
Blind Rivet ClipFix		10	50267039
Clip ClipFix		10	50267009
		10	50267034
		10	50267037
		20	50267072
		10	50267096
Expanding Rivet ClipFix		10	50267016
		20	50267017
		10	50267038
		10	50267040
		10	50267041
		20	50267042
Holding Bracket ClipFix		5	50267032
		10	50267092
		10	50267102
		10	50267175

## ClipFix

Assortment, fasteners



Version	Quantity	DU	Article no.
Mercedes-Benz 	170	1	54267005
Content		QU	
Assortment Box		1	99994509
Clip ClipFix		10	50267020
		10	50267023
		10	50267025
		10	50267071
		10	50267077
		10	50267141
		10	50267167
Expanding Rivet ClipFix		10	50267014
		10	50267015
		10	50267038
		10	50267082
		10	50267183
Grommet ClipFix		10	50267022
		10	50267026
		10	50267076
		10	50267177
Holding Bracket ClipFix		10	50267019



1

## ClipFix

Assortment, fasteners



Version	Quantity	DU	Article no.
Ford 	170	1	54267006
Content		QU	
Assortment Box		1	99994509
Blind Rivet ClipFix		10	50267089
Clip ClipFix		10	50267134
		10	50267036
		10	50267061
		10	50267099
		10	50267124
		10	50267176
		10	50267178
Expanding Rivet ClipFix		10	50267002
		10	50267112
		10	50267147
Holding Bracket ClipFix		10	50267069
		10	50267073
		10	50267105
		10	50267125
		10	50267168
Rivet ClipFix		10	50267182

## ClipFix

Assortment, fasteners



Version	Quantity	DU	Article no.
Opel 	140	1	54267007
Content		QU	
Assortment Box		1	99994509
Blind Rivet ClipFix		10	50267181
Clip ClipFix		10	50267008
		10	50267036
		10	50267046
		10	50267093
		10	50267118
		10	50267133
		10	50267167
Expanding Rivet ClipFix		10	50267001
		10	50267095
		10	50267113
Holding Bracket ClipFix		10	50267073
		10	50267140
		10	50267194



# Article no. Index



Article no. Index

114 - 116



Article number	Page
50267001	16,26,31-32,58,72,110,112
50267002	36,112
50267003	36,58,69,74
50267004	22
50267005	31,69
50267006	27,64,69
50267007	64,110
50267008	27,63,68,112
50267009	17,111
50267010	17
50267011	15,32,44
50267012	15,32,43-44
50267013	27
50267014	19,50,58,109,111
50267015	50,75,111
50267016	19,111
50267017	19,28,50,64,69,75,110-111
50267018	28,65,75
50267019	51,111
50267020	21,53,111
50267021	53
50267022	49,111
50267023	22,53,111
50267024	48
50267025	48,111
50267026	49,109,111
50267027	77
50267028	35,77
50267029	22
50267030	22
50267031	17
50267032	22,111
50267033	19
50267034	18,111
50267035	20
50267036	18,35,49,63,77,112
50267037	18,110-111
50267038	20,51,109-111
50267039	25,111
50267040	21,111
50267041	21,52,74,110-111
50267042	21,110-111
50267043	60,78
50267044	78,109
50267045	84
50267046	61,78,112
50267047	78,109
50267048	79,110
50267049	80

Article number	Page
50267050	35,80,109-110
50267051	83
50267052	79,110
50267053	74
50267054	74
50267055	81
50267056	81
50267057	79,109-110
50267058	74
50267059	81,109-110
50267060	79,109-110
50267061	81,112
50267062	79,109-110
50267063	33,44,81
50267064	82,109
50267065	82,109-110
50267066	78,109
50267067	82,109-110
50267068	83
50267069	38,85,109-110,112
50267070	54
50267071	48,111
50267072	18,111
50267073	23,38,61,84,112
50267076	49,111
50267077	54,77,111
50267078	52,82
50267079	82
50267080	18,36,58,83,110
50267081	15,32,43-44,110
50267082	28,52,65,110-111
50267083	68,110
50267084	86,110
50267085	36,83,110
50267086	28,66,69,110
50267087	15,33,45,110
50267088	64,110
50267089	16,33,39,112
50267090	83,110
50267091	84,110
50267092	23,37,111
50267093	31,61,112
50267094	84,110
50267095	59,112
50267096	17,55,111
50267097	23
50267098	42,56-57
50267099	37,112
50267100	84

Article number	Page	Article number	Page
50267101	73	50267151	40
50267102	24,111	50267152	62
50267103	79,110	50267153	40
50267104	46,73	50267154	39
50267105	33,38,112	50267155	40
50267106	30,66	50267156	40
50267107	30,66	50267157	53
50267108	47,57	50267158	60
50267109	23	50267159	62
50267110	42	50267161	23,55
50267111	46,73	50267162	60
50267112	37,112	50267163	54
50267113	59,112	50267164	54
50267114	70,75	50267166	38,54
50267115	68	50267167	55,63,111-112
50267116	21,55	50267168	24,40,85-86,112
50267117	34,46,72-73	50267169	53
50267118	61,112	50267170	29,51,60,65,70,86
50267119	75	50267171	23,54
50267120	20	50267172	24
50267121	27	50267173	53
50267122	37,61,84	50267174	51,60,76
50267123	38	50267175	22,111
50267124	39,112	50267176	41,112
50267125	39,112	50267177	49,111
50267126	17	50267178	41,112
50267127	46,73	50267179	25
50267128	24	50267180	25
50267129	27,34,67,70	50267181	62,112
50267130	29,34,67	50267182	41,112
50267131	29,66,68	50267183	29,51,65,70,111
50267132	35	50267184	20,40
50267133	61,112	50267185	30,67,71
50267134	39,112	50267186	28,64
50267135	38,67,71	50267187	83
50267136	57	50267188	29,65,71
50267137	47	50267189	24
50267138	66	50267190	62
50267140	85,109-110,112	50267191	20,77
50267141	35,48,56,80,110-111	50267192	30,62,67
50267142	48,80,110	50267193	24
50267143	80,110	50267194	63,112
50267144	76,110	50267195	63
50267145	30,67,110	50267196	52
50267146	59,70,76,110	50267199	52
50267147	16,33,37,43,45,50,59,76,86,110,112	54267001	109
50267148	15,32,43-44,110	54267002	110
50267149	85,110	54267003	110
50267150	16,34,36,43,45	54267004	111



<b>Article number</b>	<b>Page</b>
54267005	111
54267006	112
54267007	112
99994507	109-110
99994509	111-112

# Index



Index	118
-------	-----



Description	Page
<b>A</b>	
Assortment, fasteners	109-112
<b>B</b>	
Blind Rivet	16,25,33,39,62,82
<b>C</b>	
Clip	15-18,21-24,27-37,39-41,43-46,48-49, 53-56,60-64,66-71,73-74,77-81,84,86
ClipFix	15-86,109-112
<b>E</b>	
Expanding Rivet	16,18-21,23,26,28-29,31-33,36-37,40,42-43,45, 50-52,54-60,62,64-66,68-70,72,74-77,82-83,86
<b>G</b>	
Grommet	24,33,44,49,81-82
<b>H</b>	
Holding Bracket	17,22-24,30,33,37-40,48,51, 53-54,61,63,66-67,71,78,83-86
<b>R</b>	
Rivet	20,29,34,40-42,46-47,53,57,65,71-73
<b>S</b>	
Screw	30,53,66,79,82,85

# ELPARTS

# Find parts quickly!

## The new premium universal part search



herthundbuss.com/  
online-catalogue

### Free text entry

Enter any search terms  
and combinations

### Filtering

by product groups  
and criteria

### Details

A click on the article  
displays additional  
information such as  
technical data, parts and  
accessory lists, service  
information, installation  
instructions

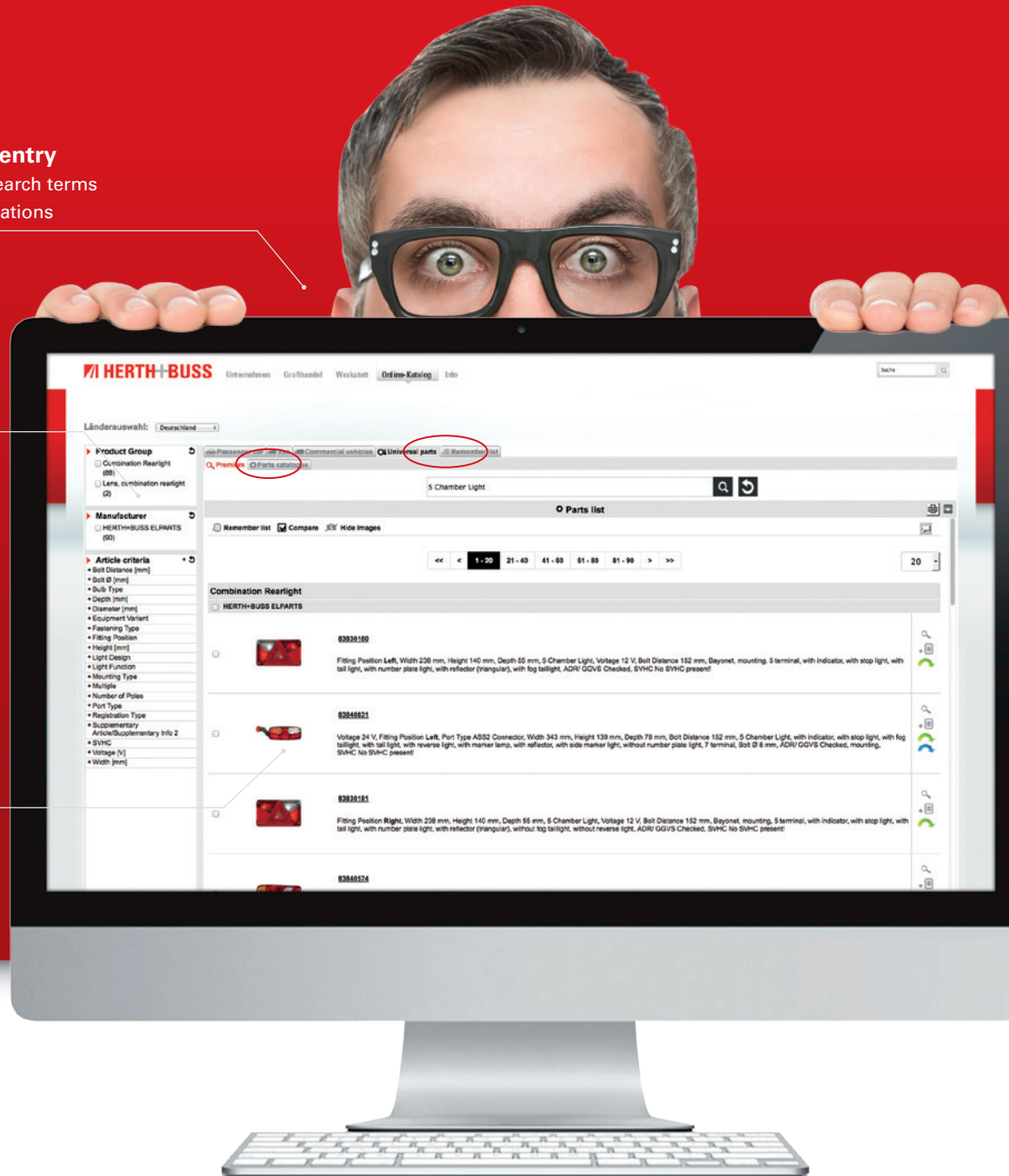

### Are you missing the spare part you need?

A significant amount of time in a workshop is devoted to meticulous universal part searches and the ever growing range of parts usually means that searches are extremely time-intensive. With the new premium search, it is now possible to filter universal parts by product groups and based on a variety of different search criteria.

**Passt immer!**

ELPARTS | JAKOPARTS

**HERTH+BUSS**





# Material for POS

## Main catalogues

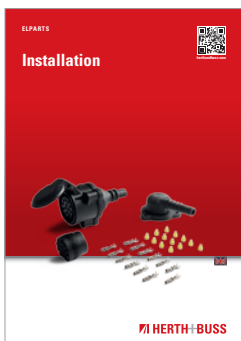

Katalog04EN

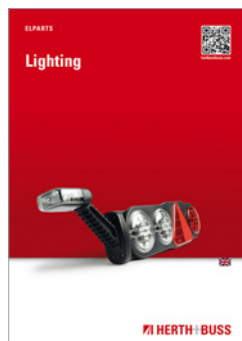

Katalog06EN

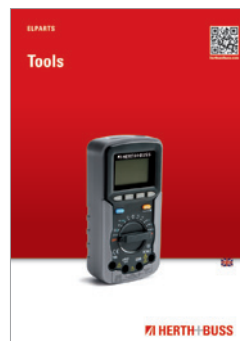

Katalog08EN

## Catalogue extracts

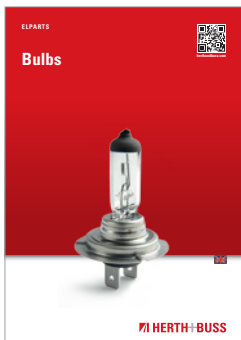

Katalog09EN

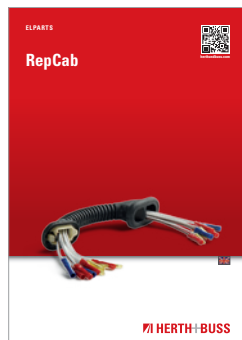

Katalog12-EN

## A1 fold-out poster

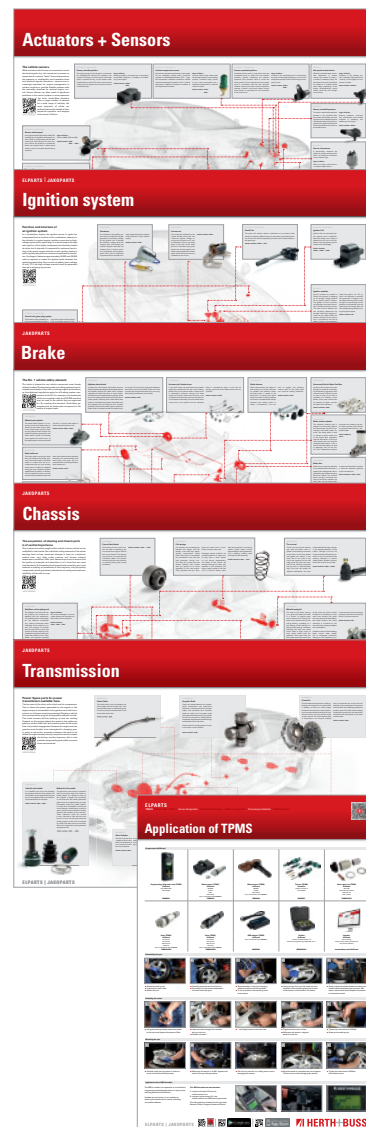

Poster47EN

Poster104EN

Poster105EN

Poster111EN

Poster112EN

Poster119EN



## Herth+Bus e-catalogues

- realistic page-turning
- zoom, article search, thumbnail view, table of contents, bookmarks ...
- links and connection to online catalogue
- can be viewed on mobile devices

[herthandbuss.com/en/catalogues](http://herthandbuss.com/en/catalogues)

**Herth+Buss Fahrzeugteile GmbH & Co. KG**  
Dieselstraße 2-4 | DE-63150 Heusenstamm

**Herth+Buss France SAS**  
ZA Portes du Vercors, 270 Rue Col de La Chau  
FR-26300 Châteauneuf-sur-Isère

**Herth+Buss Belgium Sprl**  
Rue de Fisine 9 | BE-5590 Achène

**Herth+Buss UK Ltd**  
Ground Floor, Unit 16, Londonderry Farm  
Keynsham Road, Willsbridge, Bristol | UK-BS30 6 EL

